



Önsöz

2005 yılında üretime başlayan ÖZDEMİR AMORTİSÖR "flexlift" tescilli markası ile Kayseri Organize Sanayi Bölgesinde 6000 m2 kapalı ve 30000 m2 açık alanda faaliyet göstermektedir. ÖZDEMİR AMORTİSÖR, 1986 yılından bu güne kadar 25 yıllık tecrübesi ile mobilya sektöründe hizmet vermekte olan ÖZDEMİR GROUP' un yeni üyesi olarak üretimine devam etmektedir.

ÖZDEMİR AMORTİSÖR, gazlı amortisör üretiminde başta otomotiv olmak üzere mobilya ve endüstrinin çeşitli alanlarına hitap etmektedir.

ÖZDEMİR AMORTİSÖR, kullanmış olduğu teknoloji, üretimde kalite ve hizmette sınır tanımayan anlayışıyla kısa zamanda sektörün lider üreticileri arasında girmeyi başarmış ve hem yurt içinde hem yurt dışında marka olmanın haklı gururunu yaşamaktadır. ÖZDEMİR GROUP' unda kattığı tecrübeyle de kısa zamanda ABD, Avrupa, Rusya, Afrika, Avustralya, Kafkaslar, Yakın Doğu ve Orta Doğu'da potansiyel alıcılara ulaşmayı başardı.

ÖZDEMİR AMORTİSÖR, kısa zamanda kalitesini sadece yurt içinde değil uluslararası standartlarda da kanıtlayarak, bilgi, tecrübe ve yönetim prensiplerinin yanı sıra, ISO 9001 kalite yönetim sistemi ile yönetilmekte ve TSE standartlarında ürün üretmektedir.

AR-GE çalışmalarının bilincinde olarak müşterinin daha önceden tasarlamış olduğu uygulama alanına göre bire bir diyaloga geçerek kaliteli mühendislik ve teknik çalışmalarla ilk tasarımından son montaja kadar müşterinin talep ve beklentilerine cevap vermektedir.

ÖZDEMİR AMORTİSÖR olarak ilkemiz, "Müşterilerimizin istekleri doğrultusunda, günümüz teknolojisine uygun, kaliteli ürünler üretmek, müşteri memnuniyetini artırmak için müşteri ihtiyaçlarını izlemek ve yeni ürünler tasarlayarak, dürüstlüğü-müden ve güvenilirliğimizden ödün vermeden pazar payımızı genişletmektir."

Başarımızın sırrı ÖZDEMİR AMORTİSÖR kalitesini paylaştığınız değerli müşterilerimiz bize duyduğunuz güvende saklıdır. Bu sırrı sizlerle paylaşmaya hazırız.

Saygılarımızla...

GENEL MÜDÜR



Preface

Starting to production in 2005 with the registered trademark "flexlift", Özdemir Gas Springs is in service at 6000 m² indoor and 30,000 m² outdoor area in Kayseri Organized Industry Zone. Özdemir Gas Spring is continuing to production as a new member of Özdemir Group which has been serving in the furniture sector with the experience of 25 years, since 1986.

In production of gas spring, We are mainly serving to furniture sector besides automotive and various branch of industry. Özdemir Gas Spring has achieved to participate in the leader producers of the sector with the technology we use and the manner of quality in production and unlimited service. We proud of to be a leader brand in both domestic and foreign markets. With the experience of Özdemir Group we succeeded to reach the potential buyers in USA, Europe, Russia, Africa, Caucasus, Australia, The Near East and The Middle East.

Proving our quality in not only domestic but also foreign markets, Özdemir Gas Springs is managed with ISO 9001 quality management system besides knowledge, experience and management principles. Also our products are appropriate to TSE standards.

Being aware of R&D activities and

according to applying fields determined by the customers, Özdemir Gas Springs, fulfills the customers' expectations from the initial design to last montage with high quality engineering and technical works.

As Özdemir Gas Springs, our principle is "to produce appropriate to today's technology according to our customer's demands, to improve the customer's pleasure by observing their requirements and to have a bigger marketshare with designing new products."

The secret of our achievement is hidden in the trust of our customer sharing the quality of Özdemir Gas Springs. We are ready to share this secret with you.

Yours respectfully

General Manager



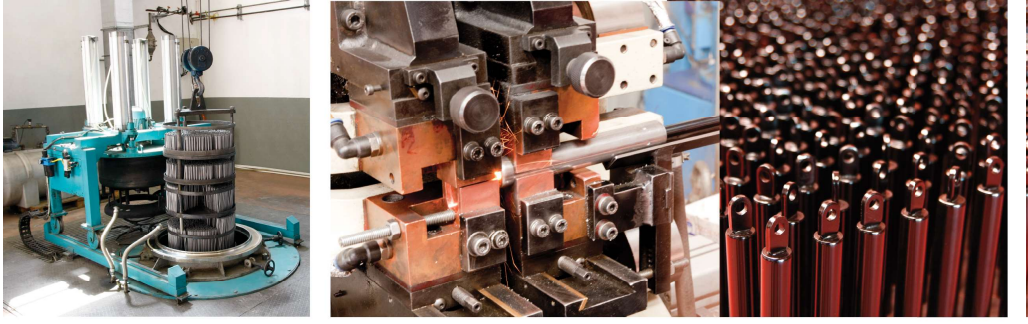

İçindekiler / Index

6-7 Teknik Bilgiler
Technical Information

8-13 Lift Amortisörler
Lift Gas Springs

15-22 Kilitli Amortisörler
Lockable Gas Springs

23-24 Mobilya Kapak Amortisörler
Furniture Cover Gas Springs

25 Damper
Damper

26-27 Paslanmaz Amortisörler
Stainless Gas Springs

28 Valfli Amortisörler
Gas Springs With Valve

29 Çekme Amortisörler
Traction Gas Springs

30-34 Boru ve Mil Bağlantı Parçaları
Rod and Tube Fittings

35-53 Araç Parça Listesi
Vehicle Part List

54 Amortisör Sipariş Faks Formu
Gas Spring Ordering Fax Form



Teknik Bilgiler / Technical Information

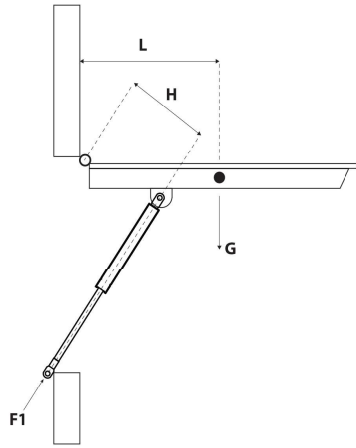

- F1** = Gazlı amortisörün kuvveti / Gas spring's force
H = Amortisörün menteşeye olan dik uzaklığı
 /Vertical distance of gas spring to hinge
L = Kapağın ağırlık merkezinin menteşeye olan uzaklığı
 /Distance of the gravity centre of the cover to hinge
M = Kapak ağırlığı / Cover weight
G = M x g

$$F1 = \frac{G \times L}{n \times H} + (\%10\text{--}\%20)$$

Amortisörler ~20°C'de üretilmektedir. Kapalı kaplarda basınç sıcaklık karşısında doğru orantılı olarak tepki gösterir. Sıcaklık artışıyla artar, sıcaklığın düşmesiyle düşer. Üretim Sıcaklığından 10°C sapmada basınç yaklaşık %3,5 oranında etkilenir.

Gas springs are produced at temperature of ~20°C. Compressed gas pressure reacts in direct proportion to temperature. Spring force rises and falls according to the variation in temperature. With per deviation of 10°C in the producing temperature, pressure is affected %3,5.

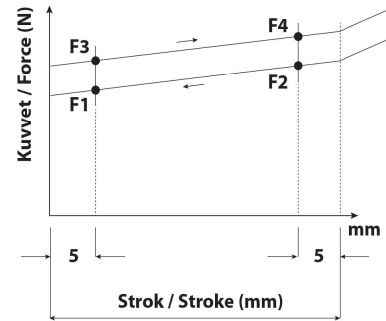
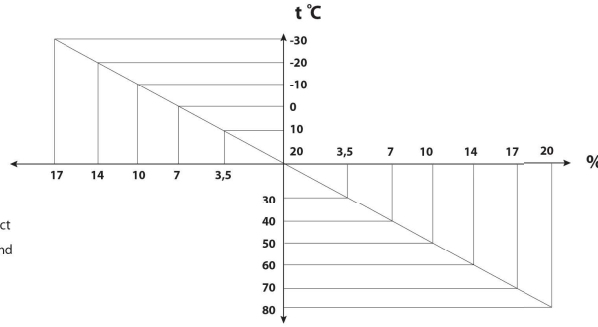

- RF** = F3 - F1
K = F2/F1 => Sıkıştırma Kuvveti / Compression Force
F1 = Kapalı amortisörün açılırken son 5mm pozisyonundaki kuvveti
 A closed gas spring's force at the last 5mm when it is opening
F2 = Kapalı amortisörün açılırken ilk 5mm pozisyonundaki kuvveti
 A closed gas spring's force at the initial 5mm when it is opening
F3 = Amortisör kapanırken ilk 5mm pozisyonundaki kuvveti
 A closing gas spring's force at
F4 = Amortisör kapanırken son 5mm pozisyonundaki kuvveti
 A closing gas spring's force at the last 5mm

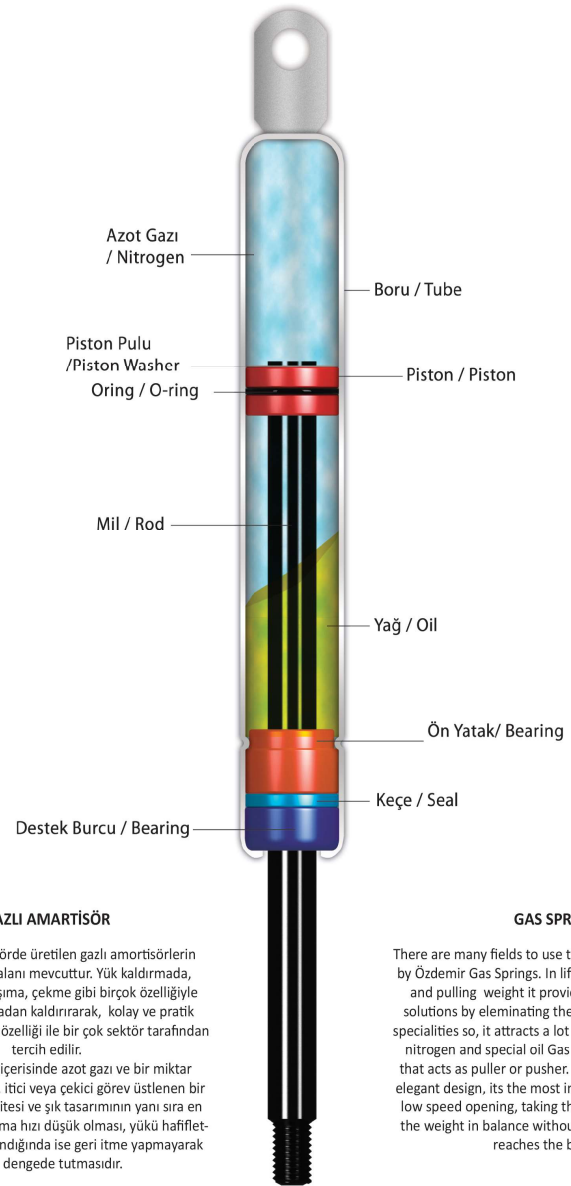

GAZLI AMORTİSÖR

Özdemir Amortisörde üretilen gazlı amortisörlerin birçok kullanım alanı mevcuttur. Yük kaldırma, dengeleme, taşıma, çekme gibi birçok özelliğiyle kas kuvvetini ortadan kaldırarak, kolay ve pratik çözümler sunar. Bu özelliği ile bir çok sektör tarafından tercih edilir.

Gazlı Amortisör, içerisinde azot gazı ve bir miktar özel yağ ile çalışır, itici veya çekici görev üstlenen bir mekanizmadır. Kalitesi ve sık tasarımının yanı sıra en önemli özelliği, açılma hızı düşük olması, yükü hafifletmesi ve sona dayandığında ise geri itme yapmayarak yükü dengede tutmasıdır.

GAS SPRING

There are many fields to use the Gas springs produced by Özdemir Gas Springs. In lifting, balancing, carrying and pulling weight it provides easy and practical solutions by eliminating the muscle power with its specialities so, it attracts a lot of sectors. Working with nitrogen and special oil Gas Spring is a mechanism that acts as puller or pusher. Besides the quality and elegant design, its the most important specialities are low speed opening, taking the pressure and holding the weight in balance without pushing-back when it reaches the bottom..

Lift Amortisör

Bu tür amortisörler yükü kontrollü bir şekilde ve efor sarf etmeden kaldırma, indirme ve dengelemede kullanılır.

Lift Gas Spring

This kind of gas spring is used to lift, lower, adjust, move and balance the weight without muscle power.

lift
6-15

amortisör / gas spring

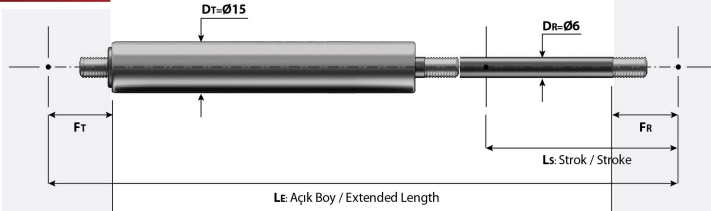

LE Açık Boy / Extended Length



Dr Mil Çapı / Rod Diameter	Dt Boru Çapı/Tube Diameter	Ls Strok / Stroke	LE Açık Boy / Extended Length	F1 Kuvvet / Force	Fr Başlık / Fitting	Ft Başlık / Fitting	CODE
6	15	20	110	50-400 NW	FLP2	FLP2	FLXS106001
		40	150				FLXS106002
		60	190				FLXS106003
		80	240				FLXS106004
		100	280				FLXS106005
		120	320				FLXS106006
6	15	150	385	50-400 NW	FTS	FTS	FLXS106007
		20	110				FLXS106008
		40	150				FLXS106009
		60	190				FLXS106010
		80	240				FLXS106011
		100	280				FLXS106012
6	15	120	320	50-700 NW	FTS	FTS	FLXS106013
		150	385				FLXS106014

MİL ÇAPI / ROD DIAMETER : 6 mm
BORU ÇAPI / TUBE DIAMETER : 15 mm
KUVVET / FORCE : 50 - 400 Newton
KUVVET TOLERANS / FORCE TOLERANCE : ± %5
STROK / STROKE : 20-150 mm
AÇIK BOY / EXTENDED LENGTH : 90-400 mm
BOY TOLERANS / LENGTH TOLERANCE : ± 2 mm
ÇALIŞMA SICAKLIĞI / OPERATING TEMP. : -30°C / +80°C
AMORTİSÖR ÖMRÜ / SPRING LIFE : 10.000 m.

Sipariş Örneği / Ordering Example

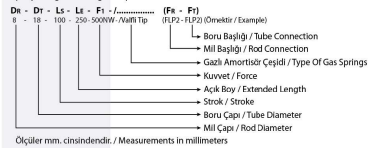

$$LE = (2xLs) + 38 + Fr + Ft$$

$$LE = (2xLs) + 43 + Fr + Ft$$

$$LE = (2xLs) + 52 + Fr + Ft$$

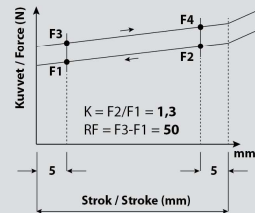

lift
8-18

amortisör / gas spring

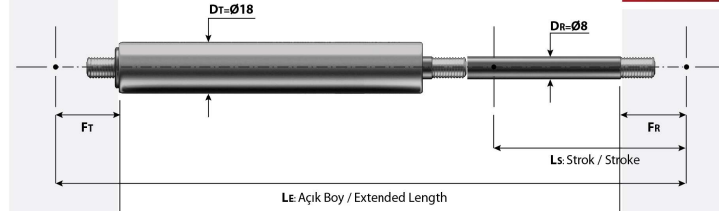

LE Açık Boy / Extended Length



Dr Mil Çapı / Rod Diameter	Dt Boru Çapı/Tube Diameter	Ls Strok / Stroke	LE Açık Boy / Extended Length	F1 Kuvvet / Force	Fr Başlık / Fitting	Ft Başlık / Fitting	CODE
8	18	60	215	50-700 NW	FLP1	FLP1	FLXS108001
		80	255				FLXS108002
		100	295				FLXS108003
		120	315				FLXS108004
		140	380				FLXS108005
		180	460				FLXS108006
8	18	200	495	50-700 NW	FTS	FTS	FLXS108007
		220	535				FLXS108008
		250	595				FLXS108009
		60	215				FLXS108010
		80	255				FLXS108011
		100	295				FLXS108012
8	18	120	315	50-700 NW	FTS	FTS	FLXS108013
		140	380				FLXS108014
		180	460				FLXS108015
		200	495				FLXS108016
		220	535				FLXS108017
		250	595				FLXS108018

MİL ÇAPI / ROD DIAMETER : 8 mm
BORU ÇAPI / TUBE DIAMETER : 18 mm
KUVVET / FORCE : 50 - 700 Newton
KUVVET TOLERANS / FORCE TOLERANCE : ± %5
STROK / STROKE : 25-300 mm
AÇIK BOY / EXTENDED LENGTH : 100-700 mm
BOY TOLERANS / LENGTH TOLERANCE : ± 2 mm
ÇALIŞMA SICAKLIĞI / OPERATING TEMP. : -30°C / +80°C
AMORTİSÖR ÖMRÜ / SPRING LIFE : 10.000 m.

Sipariş Örneği / Ordering Example

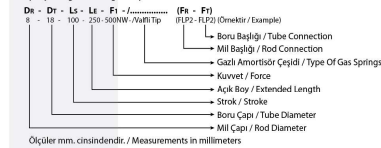

$$LE = (2xLs) + 43 + Fr + Ft$$

$$LE = (2xLs) + 49 + Fr + Ft$$

$$LE = (2xLs) + 62 + Fr + Ft$$

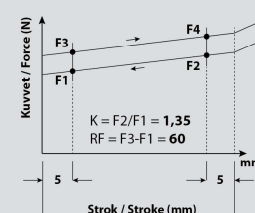

lift
10-27

amortisör / gas spring

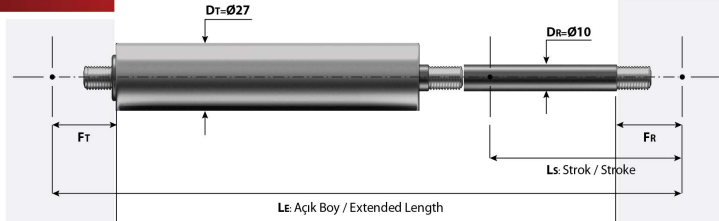

DR	Dt	Ls	LE	F1	FR	Ft	CODE
Mil Çapı / Rod Diameter	Boru Çapı/Tube Diameter	Strok / Stroke	Açık Boy / Extended Length	Kuvvet / Force	Bağlık / Fitting	Bağlık / Fitting	
10	27	100	350	500-1150 NW	FTS	FTS	FLX7210001
		150	450				FLX7210002
		200	550				FLX7210003
		250	650				FLX7210004
		300	750				FLX7210005
		350	850				FLX7210006
10	27	400	950	500-1550 NW	FLO9	FLO9	FLX7210007
		100	350				FLX7210008
		150	450				FLX7210009
		200	550				FLX7210010
		250	650				FLX7210011
		300	740				FLX7210012
		350	840				FLX7210013
		400	920				FLX7210014

MİL ÇAPI / ROD DIAMETER : 10 mm
BORU ÇAPI / TUBE DIAMETER : 27 mm
KUVVET / FORCE : 200 - 1600 Newton
KUVVET TOLERANS / FORCE TOLERANCE : ± %5
STROK / STROKE : 100-500 mm
AÇIK BOY / EXTENDED LENGTH : 350-1200 mm
BOY TOLERANS / LENGTH TOLERANCE : ± 2 mm
ÇALIŞMA SICAKLIĞI / OPERATING TEMP. : -30°C / +80°C
AMORTİSÖR ÖMRÜ / SPRING LIFE : 10.000 m.

Sipariş Örneği / Ordering Example

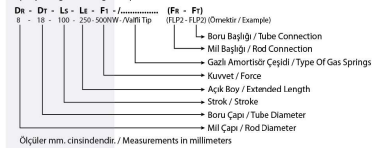

$$LE = (2xLs) + 50 + FR + FT$$

$$LE = (2xLs) + 56 + FR + FT$$

$$LE = (2xLs) + 68 + FR + FT$$

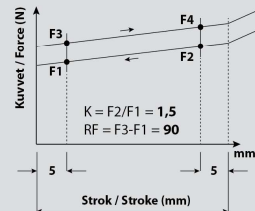

lift
14-27

amortisör / gas spring

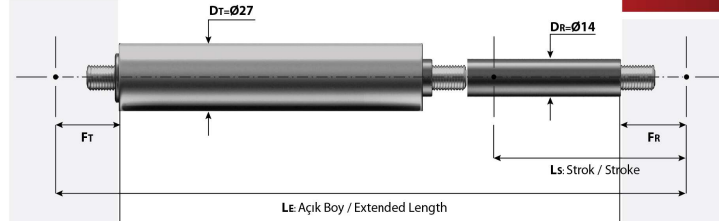

DR	Dt	Ls	LE	F1	FR	Ft	CODE
Mil Çapı / Rod Diameter	Boru Çapı/Tube Diameter	Strok / Stroke	Açık Boy / Extended Length	Kuvvet / Force	Bağlık / Fitting	Bağlık / Fitting	
14	27	100	350	250-2500 NW	FTS	FTS	FLX7214001
		150	450				FLX7214002
		200	550				FLX7214003
		250	650				FLX7214004
		300	750				FLX7214005
		350	850				FLX7214006
14	27	400	950	250-2500 NW	FLO4	FLO4	FLX7214007
		450	1050				FLX7214008
		500	1150				FLX7214009
		100	350				FLX7214010
		150	450				FLX7214011
		200	550				FLX7214012
		250	650				FLX7214013
		300	750				FLX7214014
		350	850				FLX7214015
		400	950				FLX7214016
		450	1050				FLX7214017
		500	1150				FLX7214001

MİL ÇAPI / ROD DIAMETER : 14 mm
BORU ÇAPI / TUBE DIAMETER : 27 mm
KUVVET / FORCE : 250 - 2500 Newton
KUVVET TOLERANS / FORCE TOLERANCE : ± %5
STROK / STROKE : 100-500 mm
AÇIK BOY / EXTENDED LENGTH : 350-1200 mm
BOY TOLERANS / LENGTH TOLERANCE : ± 2 mm
ÇALIŞMA SICAKLIĞI / OPERATING TEMP. : -30°C / +80°C
AMORTİSÖR ÖMRÜ / SPRING LIFE : 10.000 m.

Sipariş Örneği / Ordering Example

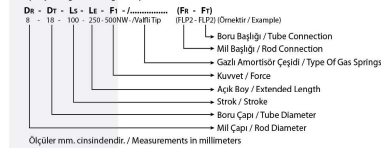

$$LE = (2xLs) + 55 + FR + FT$$

$$LE = (2xLs) + 60 + FR + FT$$

$$LE = (2xLs) + 68 + FR + FT$$

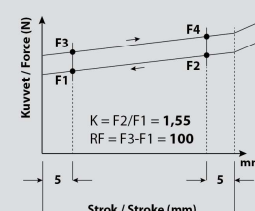

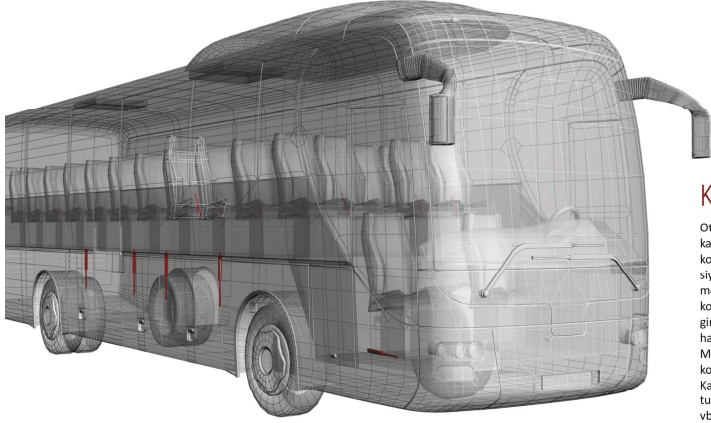

Kullanım Alanları

Otomobil (Motor ve bagaj kapaklarında, kapaklı bölmelerde, sürücü ve yolcu koltuklarında, açılabilir tavanlarda, direksiyon ayarında vb. gibi kullanım alanları mevcuttur.) , Otobüs (Sürücü ve yolcu koltuklarında, dolaplarda, bagajlarda, giriş ve çıkış kapılarında, motor kapakları, havalandırmalarda kullanılmaktadır.) , Mobilya (Baza, Mutfak dolapları, Büro koltukları, Rafa kapakları, Yazı tahtası, Katlanabilir yataklar. Havlu askısı. Çöp Kutusu, Masa, Okul Sırası, Çamaşır makinesi vb.), Tır, Trenler, Hava Araçları, Gemiler, Makine, Tıbbi Ekipman, Binalar gibi birçok kullanım alanı mevcuttur.

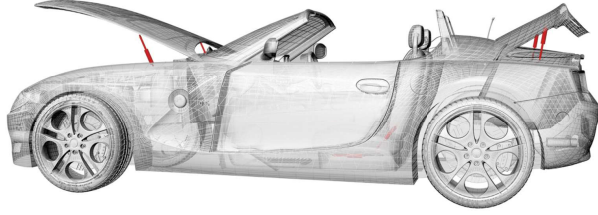

Areas Of Usage

Automobile (hood, tailgate, glove box, seats, sunroofs, hard tops, steering wheels etc.), buses (passenger and driver's seats, cabinets, baggage holds, engine covers etc.). There are many applying fields as furniture (bed bases, kitchen cabinets, shelf covers, writing boards, folding beds, towel rails, trash-cans, tables, school desks, washing machines etc.), trucks, trains, air vehicles, ships, machine and medical equipments.

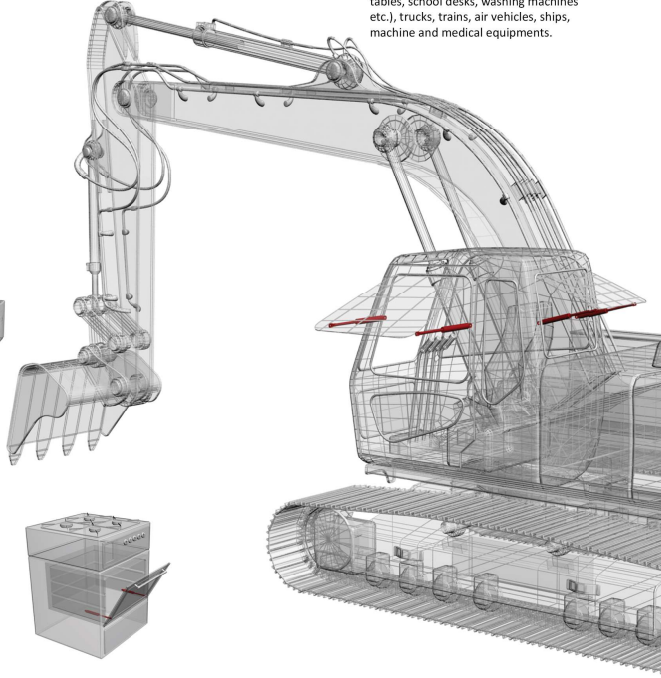
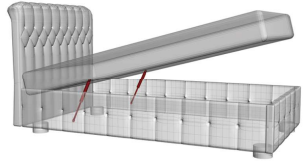
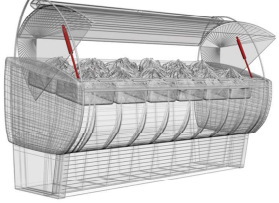

Esnek / Flexible



Rijit / Rigid



Kilitli Amortisör Lockable Gas Spring

Kilitli amortisörlerin en belirgin özelliği, yükü kaldırıp indirirken kullanıcı tarafından belirlenen bir pozisyonda sabitlenebilmesidir. Amortisörler, iç dizaynlarına göre sert veya esnek olarak tasarlanabilir.

Lockable gas spring's most essential feature is that it can be stabilized in a position determined by the user when lifting or lowering weight. According to its inner design, Lockable gas springs can be produced as rigid or flexible.

kilitli / lockable

8-22

amortisör / gas spring

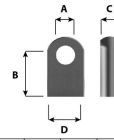
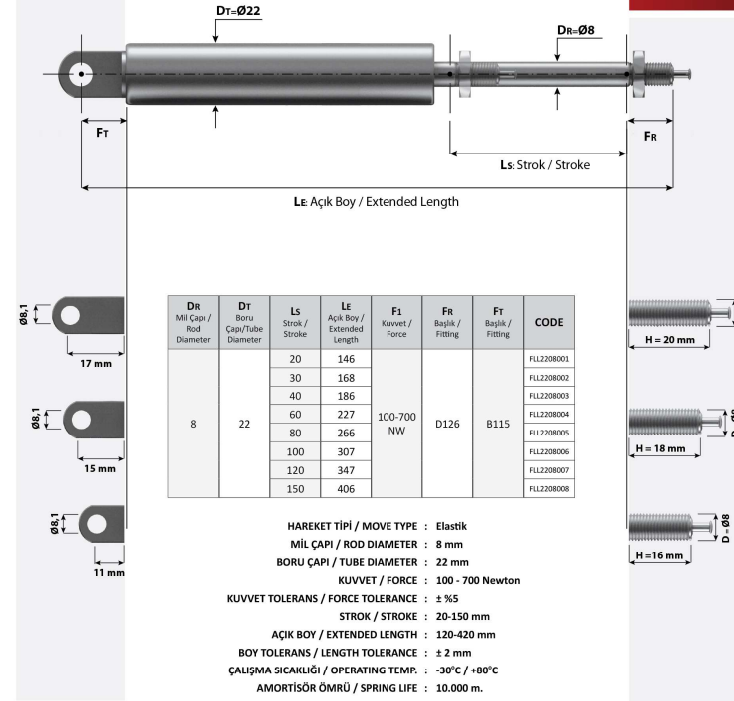

CODE	A	B	C	D	ø 22	ø 27
B111	8,1	11	10	18	*	*
B111i	8,1	11	10	18	*	*
B115	8,1	15	8	17	*	*
B115i	8,1	15	8	17	*	*
B117	8,1	17	12	20	*	*
B117i	8,1	17	12	20	*	*

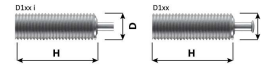

CODE	H	D	ø 22	ø 27
D126/R126	16	8	*	*
D126/R126i	16	10	*	*
D128/R128	18	8	*	*
D128/R128i	18	10	*	*
D130/R130	20	8	*	*
D130/R130i	20	10	*	*

Sipariş Örneği / Ordering Example

$D_e - D_r - L_s - L_e - F_1 - F_2$ (F₃ - F₄)
 8 - 18 - 100 - 250 - 500NW - NW8 Tip (FLP2 - FLP3) Örnektir / Example

- Boru Bağlığı / Tube Connection
- MİL Bağlığı / Rod Connection
- Çelik Amortisör Çeşidi / Type Of Gas Springs
- Kuvvet / Force
- Açık Boy / Extended Length
- Strok / Stroke
- Boru Çapı / Tube Diameter
- MİL Çapı / Rod Diameter

Ölçüler mm. cinsindedir. / Measurements in millimeters

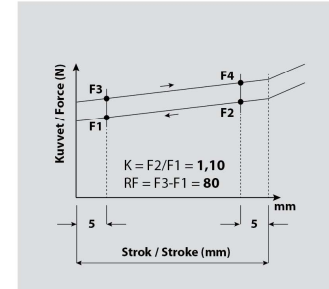

kilitli / lockable
10-22

amortisör / gas spring

DR	DT	LS	LE	F1	FR	FT	CODE
Mil Çapı / Rod Diameter	Boru Çapı / Tube Diameter	Strok / Stroke	Açık Boy / Extended Length	Kuvvet / Force	Bağlık / Fitting	Bağlık / Fitting	
10	22	20	150	100-1000 NW	D126i	B111	FL12210001
		40	190				FL12210002
		60	230				FL12210003
		80	270				FL12210004
		100	310				FL12210005
		120	350				FL12210006
		150	410				FL12210007
200	510	FL12210008					
250	610	FL12210009					

HAREKET TİPİ / MOVE TYPE : Elastik
MİL ÇAP / ROD DIAMETER : 10 mm
BORU ÇAP / TUBE DIAMETER : 22 mm
KUVVET / FORCE : 100 - 1000 Newton
KUVVET TOLERANS / FORCE TOLERANCE : ± %5
STROK / STROKE : 20-250 mm
AÇIK BOY / EXTENDED LENGTH : 150-700 mm
BOY TOLERANS / LENGTH TOLERANCE : ± 2 mm
ÇALIŞMA SICAKLIĞI / OPERATING TEMP. : -30°C +80°C
AMORTİSÖR ÖMRÜ / SPRING LIFE : 10.000 m.

CODE	A	B	C	D	Ø 22	Ø 27
B111	8,1	11	10	18	*	*
A1111	8,1	11	10	18	*	*
B115	8,1	15	8	17	*	*
B116	8,1	15	8	17	*	*
B117	8,1	17	12	20	*	*
B117i	8,1	17	12	20	*	*

CODE	H	D	Ø 22	Ø 27
D126/R126	16	8	*	*
D126/R126i	16	10	*	*
D128/R128	18	8	*	*
D128/R128i	18	10	*	*
D130/R130	20	8	*	*
D130/R130i	20	10	*	*

Sipariş Örneği / Ordering Example
Dr - Dt - Ls - Le - F1 - F2 / F3 (Fr - Ft)
Ø - 18 - 100 - 200 - 5000NW - NW/8 Tip (Ø22 - FL20) Örnektir / Example

- Boru Bağlığı / Tube Connection
- Mil Bağlığı / Rod Connection
- Gaslı Amortisör Çeşidi / Type Of Gas Springs
- Kuvvet / Force
- Açık Boy / Extended Length
- Strok / Stroke
- Boru Çapı / Tube Diameter
- Mil Çapı / Rod Diameter

Ölçüler mm.cinsindedir. / Measurements in millimeters

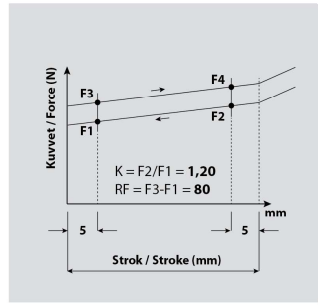

kilitli / lockable
10-27

amortisör / gas spring

DR	DT	LS	LE	F1	FR	FT	CODE
Mil Çapı / Rod Diameter	Boru Çapı / Tube Diameter	Strok / Stroke	Açık Boy / Extended Length	Kuvvet / Force	Bağlık / Fitting	Bağlık / Fitting	
10	27	20	140	150-1200 NW	D126i	B117i	FL17210001
		40	180				FL17210002
		60	220				FL17210003
		80	260				FL17210004
		100	300				FL17210005
		120	340				FL17210006
		150	400				FL17210007
200	500	FL17210008					
250	600	FL17210009					

HAREKET TİPİ / MOVE TYPE : Elastik
MİL ÇAP / ROD DIAMETER : 10 mm
BORU ÇAP / TUBE DIAMETER : 27 mm
KUVVET / FORCE : 200 - 1200 Newton
KUVVET TOLERANS / FORCE TOLERANCE : ± %5
STROK / STROKE : 20-250 mm
AÇIK BOY / EXTENDED LENGTH : 150-700 mm
BOY TOLERANS / LENGTH TOLERANCE : ± 2 mm
ÇALIŞMA SICAKLIĞI / OPERATING TEMP. : -30°C +80°C
AMORTİSÖR ÖMRÜ / SPRING LIFE : 10.000 m.

CODE	A	B	C	D	Ø 22	Ø 27
B111	8,1	11	10	18	*	*
A1111	8,1	11	10	18	*	*
B115	8,1	15	8	17	*	*
B116	8,1	15	8	17	*	*
B117	8,1	17	12	20	*	*
B117i	8,1	17	12	20	*	*

CODE	H	D	Ø 22	Ø 27
D126/R126	16	8	*	*
D126/R126i	16	10	*	*
D128/R128	18	8	*	*
D128/R128i	18	10	*	*
D130/R130	20	8	*	*
D130/R130i	20	10	*	*

Sipariş Örneği / Ordering Example
Dr - Dt - Ls - Le - F1 - F2 / F3 (Fr - Ft)
Ø - 18 - 100 - 200 - 5000NW - NW/8 Tip (Ø27 - FL20) Örnektir / Example

- Boru Bağlığı / Tube Connection
- Mil Bağlığı / Rod Connection
- Gaslı Amortisör Çeşidi / Type Of Gas Springs
- Kuvvet / Force
- Açık Boy / Extended Length
- Strok / Stroke
- Boru Çapı / Tube Diameter
- Mil Çapı / Rod Diameter

Ölçüler mm.cinsindedir. / Measurements in millimeters

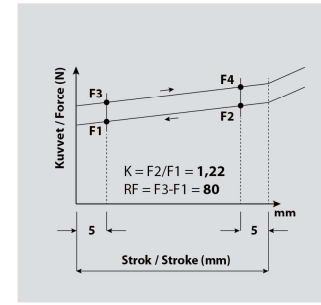

kilitli / lockable
8-22

amortisör / gas spring

DR	DT	LS	LE	F1	FR	FT	CODE
Mil Çapı / Rod Diameter	Boru Çapı/Tube Diameter	Strok / Stroke	Açık Boy / Extended Length	Kuvvet / Force	Başlık / Fitting	Başlık / Fitting	
8	22	20	150	100-700 NW	D126	B115	FL2208009
		30	175				FL2208010
		40	201				FL2208011
		60	252				FL2208012
		80	303				FL2208013
		100	354				FL2208014
120	343	FL2208015					
150	403	FL2208016					

HAREKET TİPİ / MOVE TYPE : Sert
MİL ÇAPINI / ROD DIAMETER : 8 mm
BORU ÇAPINI / TUBE DIAMETER : 22 mm
KUVVET / FORCE : 200 - 700 Newton
KUVVET TOLERANSI / FORCE TOLERANCE : ± %5
STROK / STROKE : 20-150 mm
AÇIK BOY / EXTENDED LENGTH : 120-420 mm
BOY TOLERANSI / LENGTH TOLERANCE : ± 2 mm
ÇALIŞMA SICAKLIĞI / OPERATING TEMP. : -30°C / +80°C
AMORTİSÖR ÖMRÜ / SPRING LIFE : 10.000 m.

Sipariş Örneği / Ordering Example
 D8 - Dr8 - Ls100 - Le200 - NW100 - D126 - B115 (F120) (Example)
 → Boru Başlığı / Tube Connection
 → Mil Başlığı / Rod Connection
 → Gazlı Amortisör Çeşidi / Type Of Gas Springs
 → Kuvvet / Force
 → Açık Boy / Extended Length
 → Strok / Stroke
 → Boru Çapı / Tube Diameter
 → Mil Çapı / Rod Diameter
 Ölçüler mm.cinsindedir. / Measurements in millimeters

CODE	A	B	C	D	Ø 22	Ø 27
B111	8,1	11	10	18	*	*
B111	8,1	11	10	18	*	*
B115	8,1	15	8	17	*	*
B115	8,1	15	8	17	*	*
B117	8,1	17	12	20	*	*
B117	8,1	17	12	20	*	*

CODE	H	D	Ø 22	Ø 27
D126/R126	16	8	*	*
D126/R126	16	10	*	*
D128/R128	18	8	*	*
D128/R128	18	10	*	*
D130/R130	20	8	*	*
D130/R130	20	10	*	*

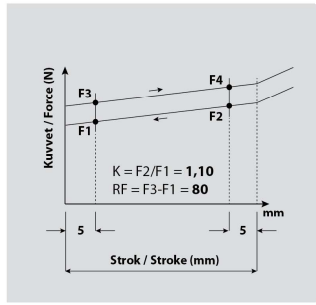

DR	DT	LS	LE	F1	FR	FT	CODE
Mil Çapı / Rod Diameter	Boru Çapı/Tube Diameter	Strok / Stroke	Açık Boy / Extended Length	Kuvvet / Force	Başlık / Fitting	Başlık / Fitting	
10	22	20	160	100-1000 NW	D126i	B111	FL2210010
		40	215				FL2210011
		60	272				FL2210012
		80	331				FL2210013
		100	386				FL2210014
		120	446				FL2210015
		160	547				FL2210016
		200	670				FL2210017
		250	813				FL2210018

HAREKET TİPİ / MOVE TYPE : Sert
MİL ÇAPINI / ROD DIAMETER : 10 mm
BORU ÇAPINI / TUBE DIAMETER : 22 mm
KUVVET / FORCE : 100 - 1000 Newton
KUVVET TOLERANSI / FORCE TOLERANCE : ± %5
STROK / STROKE : 20-250 mm
AÇIK BOY / EXTENDED LENGTH : 160-850 mm
BOY TOLERANSI / LENGTH TOLERANCE : ± 2 mm
ÇALIŞMA SICAKLIĞI / OPERATING TEMP. : -30°C / +80°C
AMORTİSÖR ÖMRÜ / SPRING LIFE : 10.000 m.

Sipariş Örneği / Ordering Example
 D10 - Dr10 - Ls100 - Le160 - NW100 - D126i - B111 (F120) (Example)
 → Boru Başlığı / Tube Connection
 → Mil Başlığı / Rod Connection
 → Gazlı Amortisör Çeşidi / Type Of Gas Springs
 → Kuvvet / Force
 → Açık Boy / Extended Length
 → Strok / Stroke
 → Boru Çapı / Tube Diameter
 → Mil Çapı / Rod Diameter
 Ölçüler mm.cinsindedir. / Measurements in millimeters

CODE	A	B	C	D	Ø 22	Ø 27
B111	8,1	11	10	18	*	*
B111	8,1	11	10	18	*	*
B115	8,1	15	8	17	*	*
B115	8,1	15	8	17	*	*
B117	8,1	17	12	20	*	*
B117	8,1	17	12	20	*	*

CODE	H	D	Ø 22	Ø 27
D126/R126	16	8	*	*
D126/R126	16	10	*	*
D128/R128	18	8	*	*
D128/R128	18	10	*	*
D130/R130	20	8	*	*
D130/R130	20	10	*	*

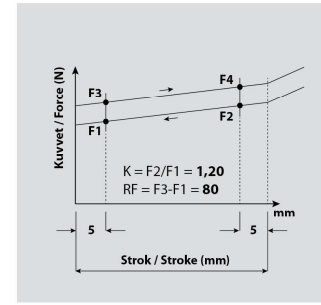

kilitli / lockable
10-22

amortisör / gas spring



kilitli / lockable
10-27

amortisör / gas spring

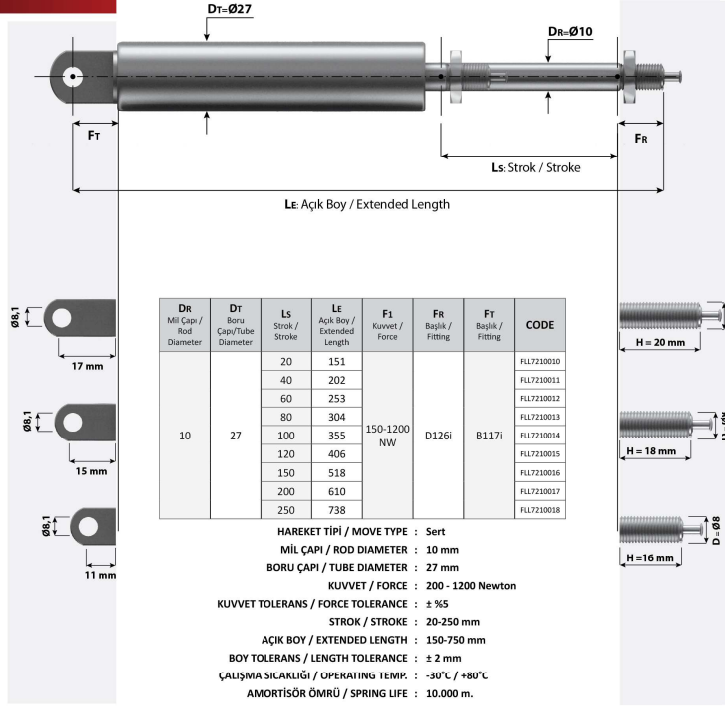

CODE	A	B	C	D	Ø 22	Ø 27
B111	8,1	11	10	18	*	*
B111i	8,1	11	10	18	*	*
B115	8,1	15	8	17	*	*
B115i	8,1	15	8	17	*	*
B117	8,1	17	12	20	*	*
B117i	8,1	17	12	20	*	*

CODE	H	D	Ø 22	Ø 27
D126/Ø126	16	8	*	*
D126/Ø126i	16	10	*	*
D128/Ø128	18	8	*	*
D128/Ø128i	18	10	*	*
D130/Ø130	20	8	*	*
D130/Ø130i	20	10	*	*

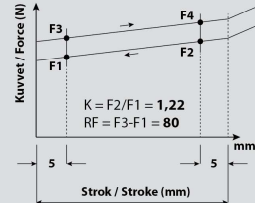
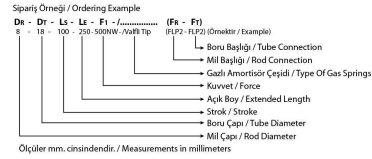

Mobilya Kapak Amortisör
Furniture Cover Gas Spring



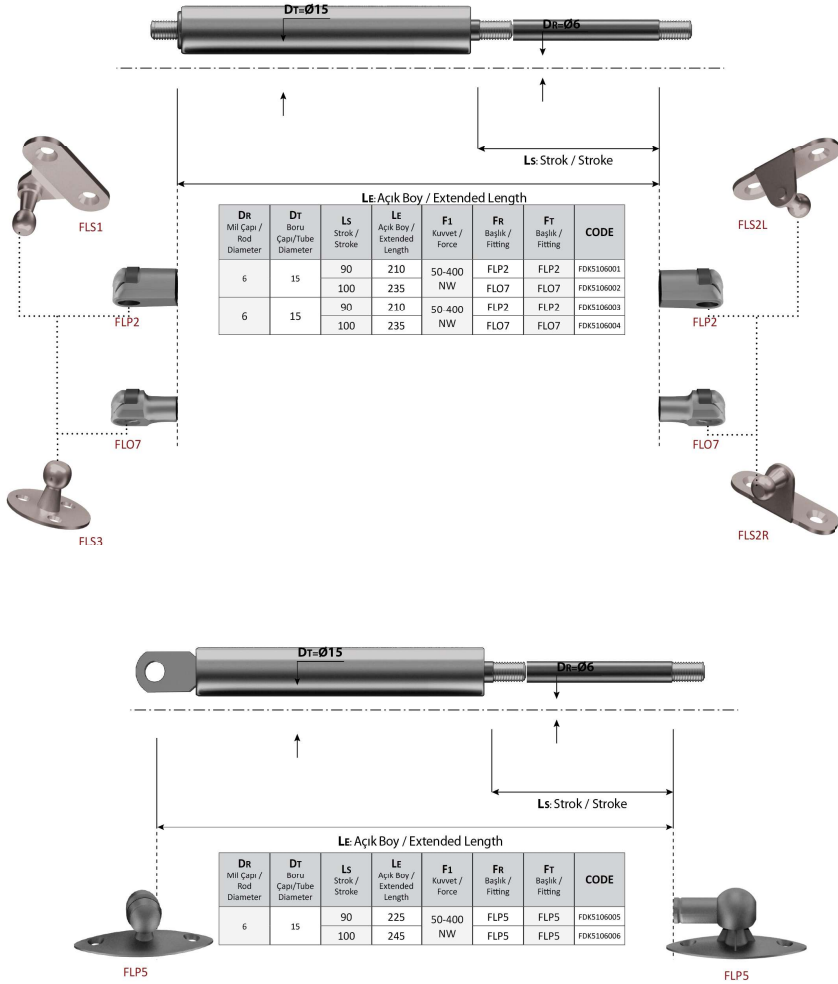

Damperler kullanıldığı alanlarda hidrolik yapısı ile özel tasarımı sayesinde titreşimi emer ve sesi azaltır. Daha çok tarım ve yapı sektöründe kullanılan ve otomobillerin motor, direksiyon mili gibi bölgelerde darbe emici olarak kullanılır.

Dampers, absorb the vibration and reduces the noise with its hydraulic structure and special design. They are mostly used as shock absorber in the seats of agricultural and constructional vehicles and at the engine of automobile.

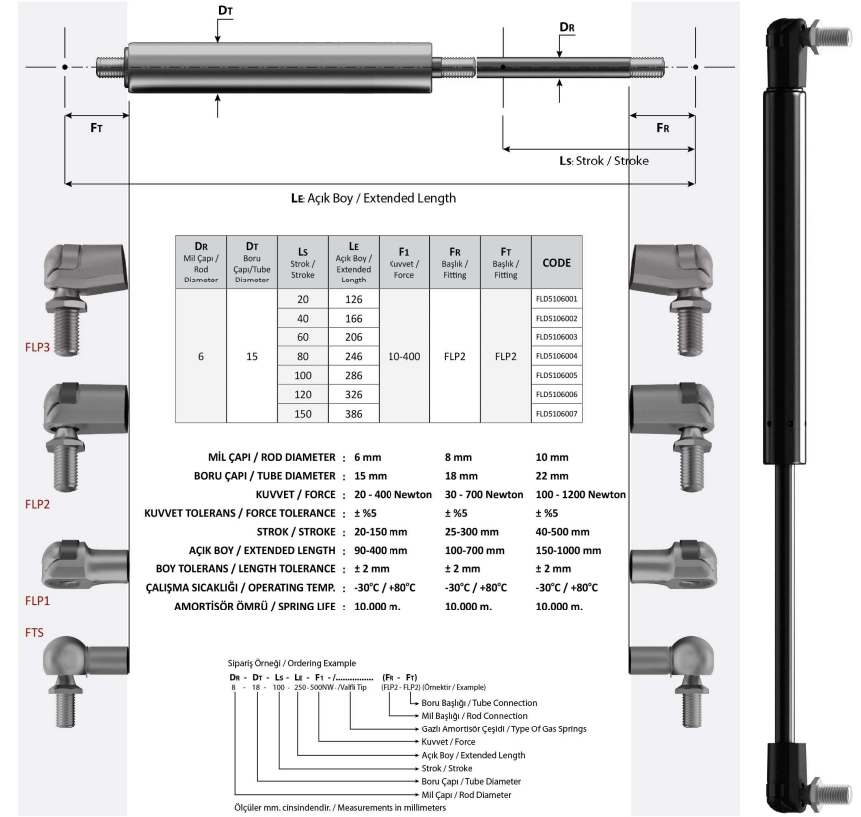

Paslanmaz Amortisör Stainless Gas Spring

Yüksek korozyon direnci gerektiren deniz gıda ve medikal sanayinde tercih edilir. Çalışma prensibi standart lift amortisörlerle aynıdır.

Stainless gas spring is mainly used in medical, marine and food industry that require strong resistance to corrosion.

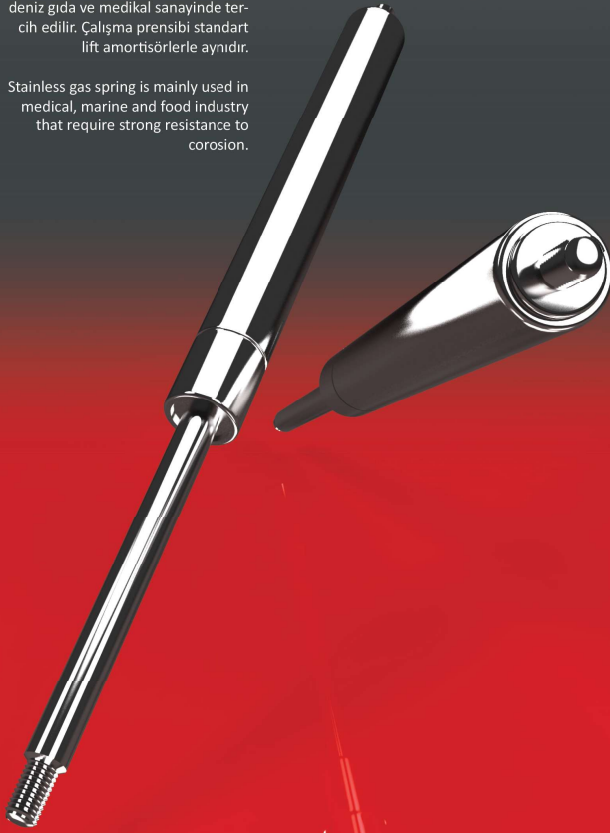

Paslanmaz
Stainless

amortisör / gas spring

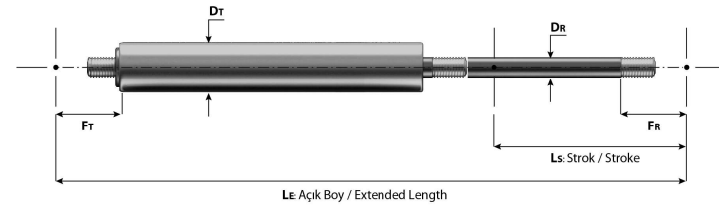

Tip		Ls		Le		F Kuvvet / Force	
Dr	Dt	Min.	Max.	Min.	Max.	Min.	Max.
6	15	10	160	90	400	10	400
8	18	50	300	180	700	50	750
10	22	50	400	200	900	150	1200
10	27	100	500	300	1000	250	1500
14	27	100	500	300	1500	250	2700

MİL ÇAP / ROD DIAMETER :	6 mm	8 mm	10 mm	10 mm
BORU ÇAP / TUBE DIAMETER :	15 mm	18 mm	22 mm	27 mm
KUVVET / FORCE :	10 - 400 Newton	50 - 750 Newton	150 - 1200 Newton	250 - 1500 Newton
KUVVET TOLERANS / FORCE TOLERANCE :	± %5	± %5	± %5	± %5
STROK / STROKE :	10-160 mm	50-300 mm	50-400 mm	100-500 mm
AÇIK BOY / EXTENDED LENGTH :	90-400 mm	180-700 mm	200-900 mm	300-1000 mm
BOY TOLERANS / LENGTH TOLERANCE :	± 2 mm	± 2 mm	± 2 mm	± 2 mm
ÇALIŞMA SICAKLIĞI / OPERATING TEMP. :	-30°C / +80°C	-30°C / +80°C	-30°C / +80°C	-30°C / +80°C
AMORTİSÖR ÖMRÜ / SPRING LIFE :	10.000 m.	10.000 m.	10.000 m.	10.000 m.

Sipariş Örneği / Ordering Example

Dr - Dt - Ls - Le - Fr - Fk / (S1P2 - FLP3) (Örnek / Example)
 6 - 18 - 100 - 250 - 500N - 2x111 Tip
 → Boru Bağlığı / Tube Connection
 → Mil Bağlığı / Rod Connection
 → Gazlı Amortisör Çeşidi / Type Of Gas Springs
 → Kuvvet / Force
 → Açık Boy / Extended Length
 → Strok / Stroke
 → Boru Çapı / Tube Diameter
 → Mil Çapı / Rod Diameter

Ölçüler mm. cinsindedir. / Measurements in millimeters

valfli
with valve

amortisör / gas spring



Valfli amortisörün en önemli özelliği amortisör basıncının kullanıcı tarafından ayarlanabilmesidir. Bu özelliği sayesinde yük hesabı yapmaya gerek kalmaz.

The most essential feature of the gas spring with valve is that its force can be adjusted by user with a small pin on the side of the tube. With this feature there is no need to calculate the weight.

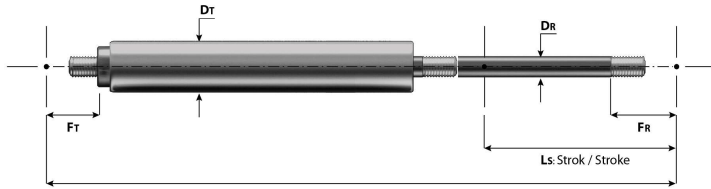

Le Açık Boy / Extended Length

Tip		Ls		Le		F Kuvvet / Force	
Dr	Dt	Min.	Max.	Min.	Max.	Min.	Max.
6	15	10	160	90	400	10	400
8	18	50	300	180	700	50	750
10	21	50	400	200	900	200	1200
10	22	50	400	200	900	200	1200
10	27	100	400	300	1000	250	1500
14	27	100	400	300	1000	250	2700

KUVVET TOLERANS / FORCE TOLERANCE : $\pm 5\%$

BOY TOLERANS / LENGTH TOLERANCE : ± 2 mm

ÇALIŞMA SICAKLIĞI / OPERATING TEMP. : $-30^{\circ}\text{C} / +80^{\circ}\text{C}$ (Farklı çalışma sıcaklıklarında lütfen teknik destek alınız)

Please ask for technical support for different operating temperatures

AMORTİSÖR ÖMRÜ / SPRING LIFE : 10.000 m.

Sipariş Örneği / Ordering Example

De - Dr - Ls - Le - F1 - fmm (Fa - Fr)
8 - 18 - 100 - 250 - 500NW - Valfli Tip (FLP2 - FLP2) (Örnekler / Example)
→ Boru Bağlığı / Tube Connection
→ Mil Bağlığı / Rod Connection
→ Gazlı Amortisör Çeşidi / Type Of Gas Springs
→ Kuvvet / Force
→ Açık Boy / Extended Length
→ Strok / Stroke
→ Boru Çapı / Tube Diameter
→ Mil Çapı / Rod Diameter

Ölçüler mm. cinsindedir. / Measurements in millimeters

çekme
traction

amortisör / gas spring



Çekme amortisörlerin çalışma prensipleri lift amortisörlerin tersi yönündedir. Normal konumda mil boru içerisindedir. Lift amortisörlerde mili itmek için kuvvet uygulanırken çekme amortisörlerde çekmek için kuvvet uygulanır.

Traction gas spring's operating system is opposite to lift gas spring. When it is not working the rod stays inside of the tube. In standart lift gas spring, force is applied to pull out the rod from the tube but in traction gas springs force is applied to push in the rod to tube.

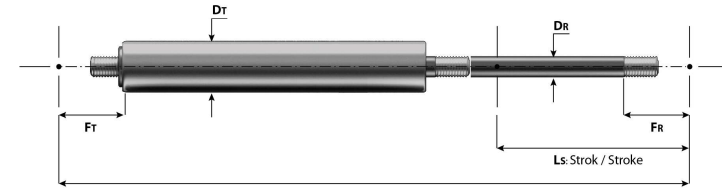

Le Açık Boy / Extended Length

Tip		Ls		Le		F Kuvvet / Force	
Dr	Dt	Min.	Max.	Min.	Max.	Min.	Max.
8	18	100	300	300	700	0	500
10	21	100	300	300	700	0	750
10	22	100	300	300	700	0	750
10	27	100	300	400	800	0	2000
10	28	100	300	400	800	0	2000

KUVVET TOLERANS / FORCE TOLERANCE : $\pm 5\%$

BOY TOLERANS / LENGTH TOLERANCE : ± 2 mm

ÇALIŞMA SICAKLIĞI / OPERATING TEMP. : $-30^{\circ}\text{C} / +80^{\circ}\text{C}$ (Farklı çalışma sıcaklıklarında lütfen teknik destek alınız)

Please ask for technical support for different operating temperatures

AMORTİSÖR ÖMRÜ / SPRING LIFE : 10.000 m.

Sipariş Örneği / Ordering Example

De - Dr - Ls - Le - F1 - fmm (Fa - Fr)
8 - 18 - 100 - 250 - 500NW - Valfli Tip (FLP2 - FLP2) (Örnekler / Example)
→ Boru Bağlığı / Tube Connection
→ Mil Bağlığı / Rod Connection
→ Gazlı Amortisör Çeşidi / Type Of Gas Springs
→ Kuvvet / Force
→ Açık Boy / Extended Length
→ Strok / Stroke
→ Boru Çapı / Tube Diameter
→ Mil Çapı / Rod Diameter

Ölçüler mm. cinsindedir. / Measurements in millimeters

Boru ve Mil Bağlantı Parçaları



Fittings and Brackets



FTS

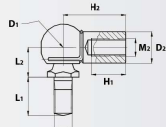

CODE	D1	M2	M1	L1	L2	H2	D2	H1	sw
FTS1	Ø8	M5	M5	10	9	22	8	10,2	8
FTS2	Ø10	M6	M6	13	11	25	10	11,5	10
FTS2-8	Ø10	M8	M8	13	11	25	10	11,5	13
FTS2-11-6	Ø10	M6	M6	12	11	21	10	11,5	10
FTS2-21-8	Ø10	M6	M8	13	11	21	10	11,5	13
FTS2-19-6	Ø10	M6	M8	13	11	19	10	11,5	13
FTS2-19-8	Ø10	M8	M8	13	11	19	10	11,5	13
FTS2-18-6	Ø10	M6	M6	12	11	18	10	11,5	10
FTS2-18-8	Ø10	M6	M8	13	11	18	10	11,5	13
FTS3-25	Ø13	M8	M8	16	13	25	13	14	13
FTS3	Ø13	M8	M8	16	13	30	13	14	13
FTS4	Ø16	M10	M10	19	16	35	16	15,5	17
FTS5	Ø16	M12	M12	19	16	35	16	15,5	17
FTS6	Ø19	M14	M14	27	22	45	22	21,5	20
FTS7	Ø19	M16	M16	27	22	45	22	21,5	20

FLO4

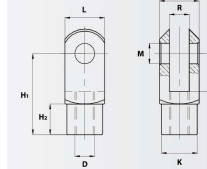

CODE	D	D GH	L	M H9	R	H1	K	H2	E	D GH
FLO4-1	4x16	8	4	4	24	8	6	8	8	M4
FLO4-2	5x20	10	5	5	30	9	7,5	20	M5	
FLO4-3	6x22	12	6	6	24	10	9	12	M6	
FLO4-4	6x24	12	6	6	36	10	9	24	M6	
FLO4-5	8x16	16	8	8	32	14	12	16	M8	
FLO4-6	8x32	16	8	8	48	14	12	32	M8	
FLO4-7	10x20	20	10	10	40	18	15	20	M10	
FLO4-8	10x40	20	10	10	60	18	15	40	M10	
FLO4-9	11x24	24	12	12	48	20	18	24	M12	
FLO4-10	12x48	24	12	12	72	20	18	48	M12	
FLO4-11	14x28	27	14	14	56	24	22,5	28	M14	
FLO4-12	15x56	27	14	14	85	24	22,5	56	M14	
FLO4-13	16x32	32	16	16	64	26	24	32	M16	
FLO4-14	16x64	32	16	16	96	26	24	64	M16	
FLO4-15	20x40	40	20	20	80	34	30	40	M20	

FLO14

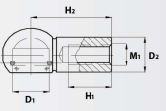

CODE	D1	M2	M1	L1	L2	H2	D2	H1	sw
FLO141	Ø8	M5	M5	10	9	22	8	10,2	8
FLO142	Ø10	M6/M8	M6/M8	13	11	25	10	11,5	10
FLO142-18	Ø10	M6	M6	13	11	18	10	11,5	10
FLO142-19	Ø10	M8/M6	M8/M6	13	11	19	10	11,5	10
FLO142-21	Ø10	M8/M6	M8/M6	13	11	21	10	11,5	10
FLO142-22	Ø10	M8/M6	M8/M6	13	11	22	10	11,5	10
FLO143	Ø13	M8/M10	M8/M10	16	13	30	13	14	13
FLO143-25	Ø13	M8	M8	16	13	25	13	14	13
FLO144	Ø16	M8/M10	M8/M10	19	16	35	16	15,5	17
FLO144-30	Ø16	M8/M10	M8/M10	19	16	30	16	15,5	17
FLO145	Ø19	M16/M14	M16/M14	27	22	45	22	21,5	20

PNT

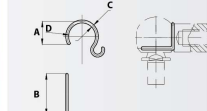

CODE	Description	D	C	A	B
PNT1	S8	7,0	1,0	6,5	12,0
PNT2	S10	8,7	1,0	7,7	12,5
PNT3	S14	11,0	1,7	9,4	14,7
PNT4	S16	13,0	1,4	11,0	19,0
PNT5	S19	20,0	1,5	16,5	24,0

KBT

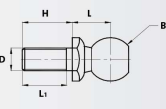

CODE	B	D	L	H	L1	sw
KBT1	Ø8	M5	9	10	8	8
KBT2	Ø10	M6/M8	11	12	10	10
KBT3	Ø10	M8	11	12	10	10
KBT4	Ø13	M8	13	16	14	13
KBT5	Ø16	M10	16	19	16	17
KBT6	Ø16	M12	16	19	16	17
KBT7	Ø19	M14	20	28	17	19
KBT8	Ø19	M16	20	28	17	19

FLO5

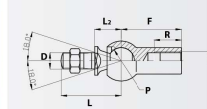

CODE	P h9	D	F	L	L2	R	PULL FORCE (N)
FLO5-1	Ø8	M5	22	19,2	9	10,2	30
FLO5-2	Ø10	M6	25	23,5	11	11,5	4
FLO5-3	Ø13	M8	30	29,5	13	14,0	60
FLO5-4	Ø16	M10	35	36	16	15,5	80
FLO5-6	Ø19	M14x1,5	45	48	20	21,5	100

FLO6

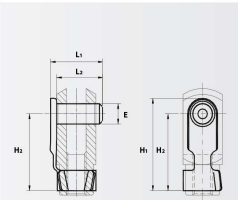

CODE	E h1	L2	L1	H2	H1
FLO6-1	4	9	11,0	15	18,5
FLO6-2	4	9	11,0	22	26
FLO6-3	5	12	13,5	19	23
FLO6-4	6	13	13,6	20	33
FLO6-5	6	14	16,0	23	28
FLO6-6	6	14	16,0	35	40
FLO6-7	8	19	21,5	31	37
FLO6-8	8	19	21,5	47	52
FLO6-9	10	23	26,0	39	45
FLO6-10	10	23	26,0	59	65
FLO6-11	12	28	31,0	47	53
FLO6-12	12	28	31,0	69	78
FLO6-13	14	32	34,0	52	62
FLO6-14	14	32	34,0	82	91
FLO6-15	16	36	39,0	62	73

FLO3

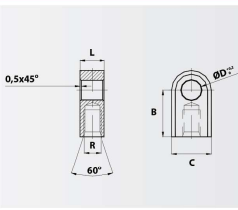

CODE	D(+0,2)	L(+0,2)	R	B	C
FLO3-1	6,1	10	M8	16	16
FLO3-2	8,1	10	M8	18	16
FLO3-3	7,28	10	M8	20	16
FLO3-4	8,1	12	M8	16	16
FLO3-5	8,1	10	M8	16	16
FLO3-6	8,1	10	M8	17	16
FLO3-7	8,1	10	M6	19	16
FLO3-8	8,1	12	M10	20	16
FLO3-9	8,1	10	M8	20	16
FLO3-10	8,1	12	M10	22	16
FLO3-11	10,1	10	M6	19	16

FLO7

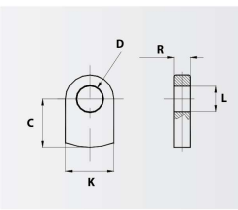

CODE	D(+0,2)	C	K	R
FLO7-1	6,1	13	13	3
FLO7-2	6,1	14	15	5
FLO7-3	6,1	17	15	3
FLO7-4	8,1	13	15	3
FLO7-5	8,1	14	15	5
FLO7-6	8,1	17	15	5
FLO7-7	10,1	17	15	5

FLO8

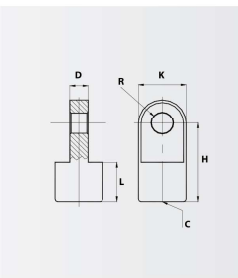

CODE	R(+0,2)	H	C	D	K	L
FLO8-1	6,1	20	M6	3	10	10
FLO8-2	8,1	22	M8	5	15	12,5
FLO8-3	8,1	22	M8	10	15	12,5
FLO8-4	8,1	22	M6	5	15	12,5
FLO8-5	8,1	25	M8	8	15	12,5
FLO8-6	8,1	30	M10	10	18	15
FLO8-7	8,1	35	M8	10	20	20
FLO8-8	10,1	25	M8	10	18	12
FLO8-9	10,1	35	M10	10	20	20
FLO8-10	10,1	35	M8	10	20	20
FLO8-11	8,1	25	M6	5	15	12,5
FLO8-12	8,1	20	M8	10	18	10,5
FLO8-13	8,1	22	M8	10	18	12,5
FLO8-14	10,1	22	M10	12	20	10
FLO8-15	10,1	30	M10	12	20	15

FLO9

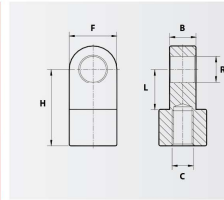

CODE	C	L	F	B	H	R
FLO9-1	M4	7	80	4	12	4,1
FLO9-2	M6	9	10	6	16	6,1
FLO9-3	M6	12	14	5	26	6,1
FLO9-4	M6	12	14	5	26	6,1
FLO9-5	M8	13	15	10	19	8,1
FLO9-6	M8	16	18	10	30	8,1
FLO9-7	M8	16	18	10	30	10,1
FLO9-8	M10	16	18	10	30	8,1
FLO9-9	M14	17	22	14	38	14,1
FLO9-10	M14	17	22	14	27	14,1

FLP15

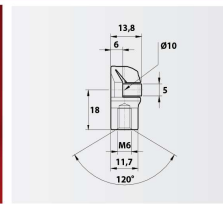

FLP1G

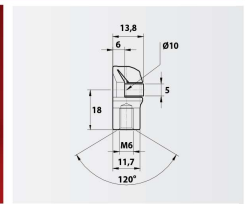

FLP2

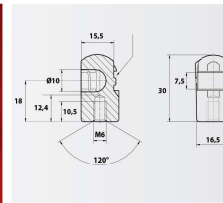

FLP3

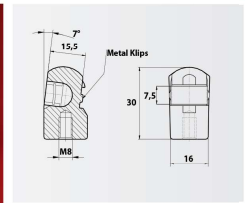

FLP4

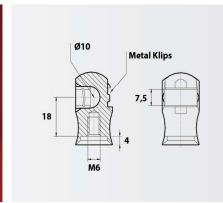

FLP5

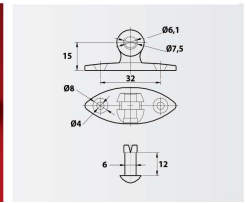

FLS4

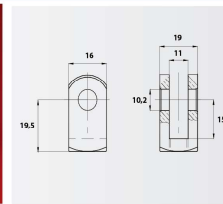

FLS5

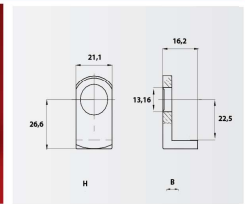

FLP8

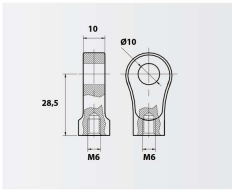

FLP9

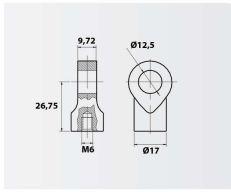

FLS1

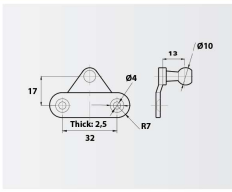
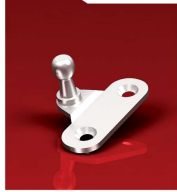

FLS3

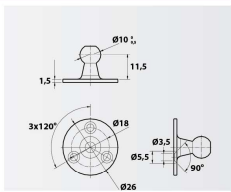

FLS2R

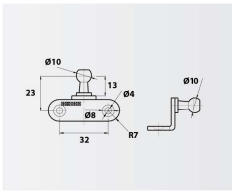
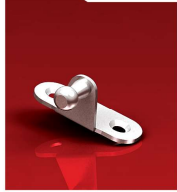

FLS2L

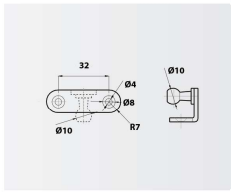

FLP1M

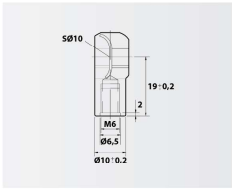

FLO2

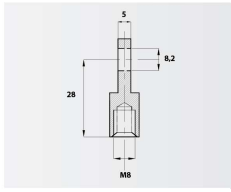
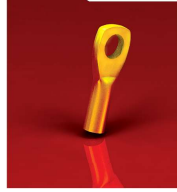

FLO1B-FLO1C

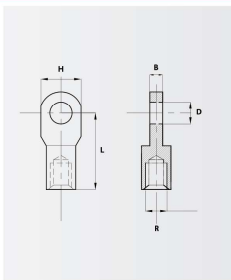

CODE	D	R	L	H	B
FLO1-1	6.2	M6	15	13	3
FLO1-2	6.2	M6	20	15	3
FLO1-3	6.2	M6	22	15	35
FLO1-4	6.2	M6	22	15	10
FLO1-5	6.2	M8	22	15	3
FLO1-6	8.2	M6	22	15	5
FLO1-7	8.2	M6	22	15	5
FLO1-8	8.2	M8	22	15	5
FLO1-9	8.2	M6	25	15	5
FLO1-10	8.2	M8	25	15	5
FLO1-11	8.2	M8	30	15	5
FLO1-12	10.2	M6	25	15	5
FLO1-13	10.2	M8	25	15	5
FLO1-14	10.2	M8	30	15	5

Otomotiv Grubu Amortisör Listesi / Gas Spring List For Automotive Industry

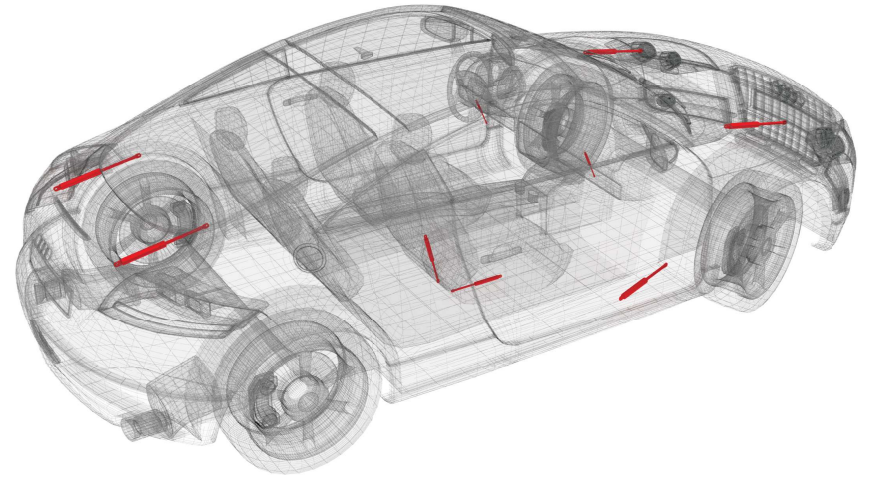



88 89 90 91 92 93
94 95 96 97 98 99
00 01 02 03 04 05
Yıl / Year

Flexlift Ref. No.

OEM

ALFA ROMEO				
Alfa 33	33	82-89	FLX380090A1001	605025230
Alfa 33	1.7I	01/86-89	FLX380090A1002	605064410
Alfa 33	RestylingIT	01/90-	FLX380090A1003	605779790
Alfa 33	RestylingSH	01/89-	FLX380090A1004	605704350
Alfa 145	930	01/94-07/97	FLX380090A1005	605679490
Alfa 145	930	08/97-01/01	FLX380090A1006	605679490
Alfa 146	930	02/95-02/96	FLX380090A1007	606125650
Alfa 146	930	01/94-06/99	FLX380090A1008	606048230
Alfa 146	930	07/99-01/01	FLX380090A1009	606048230
Alfa 146	930Sport	03/96-06/99	FLX380090A1010	606221670
Alfa 146	930Sport	07/99-01/01	FLX380090A1011	606125650
Alfa 147	937	01/01-	FLX380090A1012	467715510
Alfa 155	167	01/92-12/97	FLX380090A1013	605405320
Alfa 155	167	01/92-12/97	FLX380090A1014	605831920
Alfa 156	932	09/97-08/00	FLX380090A1015	606547240
Alfa 156	932	09/97-08/00	FLX380090A1016	606516770
Alfa 156	932	09/00-	FLX380090A1017	606547240
Alfa 156	932	09/00-	FLX380090A1018	606516770
Alfa 156	932Sport	09/97-	FLX380090A1019	606576850
Alfa 164	164	01/87-08/91	FLX380090A1020	605661470
Alfa 164	164	09/91-06/97	FLX380090A1021	605917620
Alfa 166	936	09/98-	FLX380090A1022	606224240
Alfa 166	936	09/98-10/00	FLX380090A1023	606588240
Alfa Spicier	916	10/95-08/00	FLX380090A1024	606221670
AUDI				
Audi 80/80Quattro	81.85	08/84-08/86	FLX380090A2001	811827552
Audi 80/80Quattro	81.85	08/84-08/86	FLX380090A2002	811827552A
Audi 80/80Quattro	89.8A	09/86-09/91	FLX380090A2003	893827552
Audi 80/80Quattro	89.8A	09/86-09/91	FLX380090A2004	893827552A
Audi 80/80Quattro	89.8A	09/89-09/91	FLX380090A2005	893823360
Audi 80/80Quattro	8C	08/91-10/94	FLX380090A2006	8A0823360A
Audi 80/80Quattro	8C	08/91-10/94	FLX380090A2007	8A5827552
Audi 80/80Quattro	8C	08/91-10/94	FLX380090A2008	8A5827552A
Audi 80Avant/AvantQuattro	8CB4	08/91-10/94	FLX380090A2009	8A0823360A
Audi 80Avant/AvantQuattro	8C.B4	08/91-10/94	FLX380090A2010	8A9827552D
Audi 90/90Quattro	81.85	08/84-03/87	FLX380090A2011	811827552
Audi 90/90Quattro	81.85	08/84-03/87	FLX380090A2012	811827552A
Audi 90/90Quattro	89.8A	04/87-12/91	FLX380090A2013	893823360
Audi 90/90Quattro	89.8A	04/87-12/91	FLX380090A2014	893827552
Audi 90/90Quattro	89.8A	04/87-12/91	FLX380090A2015	893827552A
Audi 100	44Ch.44-F-115150	08/82-04/85	FLX380090A2016	443823359C
Audi 100	44Ch.44-F-115150	08/82-04/85	FLX380090A2017	443823359D
Audi 100	44Ch.44-F-115151	04/85-12/90	FLX380090A2018	443823359B
Audi 100	4A	12/90-07/94	FLX380090A2019	4A0823359B
Audi 100	4A	12/90-07/94	FLX380090A2020	4A0823359C
Audi 100	4A	12/90-07/94	FLX380090A2021	4B3823359
Audi 100	4A	12/90-07/94	FLX380090A2022	4A5827552
Audi 100 Avant	4A	08/82-12/90	FLX380090A2023	4A5827551
Audi 100 Avant	4A	12/90-07/94	FLX380090A2024	4A9827552
Audi 200	44Ch.44-F-115150	08/82-04/85	FLX380090A2025	443823359C
Audi 200	44Ch.44-F-115151	08/82-04/85	FLX380090A2026	443823359D
Audi 200	44Ch.44-F-115151	04/85-12/90	FLX380090A2027	443823359B
Audi 200 Avant	4A	08/82-12/90	FLX380090A2028	4A5827551
Audi A2	8Z	02/00-	FLX380090A2029	8Z0827552A
Audi A2	8Z	02/00-	FLX380090A2030	8Z0827552B
Audi A3	8L	09/96-08/00	FLX380090A2031	8L0823359
Audi A3	8L	09/96-08/00	FLX380090A2032	8D9827552
Audi A3	8L	08/00-	FLX380090A2033	8L0823359
Audi A4	800	01/94-11/00	FLX380090A2034	8D0823354
Audi A4	800	01/94-11/00	FLX380090A2035	8D0823359
Audi A4	800	01/94-11/00	FLX380090A2036	8D0823359A
Audi A4	800	01/94-11/00	FLX380090A2037	8D0823359B
Audi A4	800	01/94-11/00	FLX380090A2038	8D5827552
Audi A4	800	01/94-11/00	FLX380090A2039	8D5827552A
Audi A4	800	01/94-11/00	FLX380090A2040	8D5827552B
Audi A4	800	01/94-11/00	FLX380090A2041	8D5827552C
Audi A4	800	01/94-11/00	FLX380090A2042	8D5827552D
Audi A4	800	01/94-11/00	FLX380090A2043	8D5827552F
Audi A4	800	11/00-	FLX380090A2044	8E0823359A
Audi A4 Avant	800000	11/95-11/00	FLX380090A2045	8D9827552
Audi A4 Avant	800000	09/01-	FLX380090A2046	8E0823359A
Audi A6	4BCh.4B-Y-120000	08/97-04/00	FLX380090A2047	4B5827552C
Audi A6	4BCh.4B-Y-120000	08/97-04/00	FLX380090A2048	4B5827552C
Audi A6	4BCh.4B-Y-120000	08/97-04/00	FLX380090A2049	4B5827552D
Audi A6	4BCh.4B-I-000001	05/00-	FLX380090A2050	4B5827552F
Audi A6	4B	08/97-04/00	FLX380090A2051	3B082339A



88 89 90 91 92 93
94 95 96 97 98 99
00 01 02 03 04 05
Yıl / Year

Flexlift Ref. No.

OEM

Audi A6	4B	08/97-04/00	FLX380090A2052	3B0823359
Audi A6	4B	08/97-04/00	FLX380090A2053	3B0823359B
Audi A6	4B	08/97-04/00	FLX380090A2054	4B0823359A
Audi A6	4B	08/97-04/00	FLX380090A2055	4B0823359B
Audi A6	4B	08/97-04/00	FLX380090A2056	4B0823359C
Audi A6	A4C4	06/94-08/97	FLX380090A2057	4A5827552
Audi A6	A4.C4	06/94-08/97	FLX380090A2058	4B3823359
Audi A6 Avant	4A	06/94-08/97	FLX380090A2059	4A9827552
Audi A6 Avant	4BCh.4B-Y-120000	08/97-04/00	FLX380090A2060	4B9827552A
Audi A6 Avant	4BCh.4B-Y-120001	04/00-	FLX380090A2061	4B9827552G
Audi A6 Avant	4BCh.4B-Y-120001	04/00-	FLX380090A2062	4B9827552J
Audi A6 Avant	4BCh.4B-Y-120001	04/00-	FLX380090A2063	4B9827552F
Audi A6 Avant	4BCh.4B-Y-120001	04/00-	FLX380090A2064	4B9827552H
Audi A6 Avant	4B	08/97-04/00	FLX380090A2065	3B082339A
Audi A6 Avant	4B	08/97-04/00	FLX380090A2066	3B0823359
Audi A6 Avant	4B	08/97-04/00	FLX380090A2067	3B0823359B
Audi A6 Avant	4B	08/97-04/00	FLX380090A2068	4B0823359B
Audi A6 Avant	4B	08/97-04/00	FLX380090A2069	4B0823359C
Audi A6 Avant	A4	06/94-08/97	FLX380090A2070	4B3823359
Audi Cabriolet	89Ch.8G-P-003612	12/92-	FLX380090A2071	8G0827552C
Audi Cabriolet	89	06/91-	FLX380090A2072	8A0823360A
Audi Cabriolet	89.83Ch.8G-P-003611	06/91-12/92	FLX380090A2073	8G0827552A
Audi Coupe/CoupeQuattro	81.85	08/81-12/87	FLX380090A2074	855827552F
Audi Coupe/CoupeQuattro	81.85	08/81-12/87	FLX380090A2075	855827552G
Audi Coupe/CoupeQuattro	81.85	08/81-12/87	FLX380090A2076	855827552F
Audi Coupe/CoupeQuattro	81.85	08/81-12/87	FLX380090A2077	855827552G
Audi Coupe/CoupeQuattro	8B	11/88-12/95	FLX380090A2078	895527552A
Audi Coupe/CoupeQuattro	8B	11/88-12/95	FLX380090A2079	895827552A
Audi Coupe/CoupeQuattro	8B	11/88-12/95	FLX380090A2080	895827552A
Audi Coupe/CoupeQuattro	8B	11/88-12/95	FLX380090A2081	895827552A
Audi Coupe/CoupeQuattro	8C	11/88-12/95	FLX380090A2082	8A0823360A
Audi Coupe/CoupeQuattro	Coupe8N	06/98-	FLX380090A2083	8N0823359
AudiTT	Coupe8N	06/98-	FLX380090A2084	8N0827552
AudiTT	Roadster8N	06/98-	FLX380090A2085	8N0823359
BMW				
BMW 3-erSerie	E30	12/85-04/89	FLX380090B1001	5124193742
BMW 3-erSerie	E30	12/85-04/89	FLX380090B1002	51248103180
BMW 3-erSerie	E30	04/89-03/93	FLX380090B1003	51248103118
BMW 3-erSerie	E30	09/87-06/94	FLX380090B1004	5124194796
BMW 3-erSerie	E30	10/82-06/94	FLX380090B1005	11811906286
BMW 3-erSerie	E30	10/82-06/94	FLX380090B1006	51231906286
BMW 3-erSerie	E36	04/93-08/99	FLX380090B1007	51238119558
BMW 3-erSerie	E36	04/93-08/99	FLX380090B1008	51248151579
BMW 3-erSerie	E36	01/92-04/99	FLX380090B1009	51238119558
BMW 3-erSerie	E36	01/92-04/99	FLX380090B1010	51241960862
BMW 3-erSerie	E36	01/92-04/99	FLX380090B1011	51242264448
BMW 3-erSerie	E36	05/95-08/99	FLX380090B1012	51231960852
BMW 3-erSerie	E36	05/95-08/99	FLX380090B1013	51248171158
BMW 3-erSerie	E36	05/95-08/99	FLX380090B1014	51248217305
BMW 3-erSerie	E36	12/96-05/98	FLX380090B1015	51231960852
BMW 3-erSerie	E36	12/96-05/98	FLX380090B1016	51241960862
BMW 3-erSerie	E36	12/96-05/98	FLX380090B1017	51242264448
BMW 3-erSerie	E36Compact	03/94-08/00	FLX380090B1018	51231960852
BMW 3-erSerie	E36Compact	03/94-08/00	FLX380090B1019	51248230070
BMW 3-erSerie	E39Compact	09/94-09/94	FLX380090B1020	51248146290
BMW 3-erSerie	E36Compact	03/94-08/00	FLX380090B1021	51248206652
BMW 3-erSerie	E36Compact	03/94-08/00	FLX380090B1022	51242491349
BMW 3-erSerie	E46	05/99-	FLX380090B1023	51248227895
BMW 3-erSerie	E46	05/99-	FLX380090B1024	51248232873
BMW 3-erSerie	E46	05/98-	FLX380090B1025	51244212802
BMW 3-erSerie	E46	05/98-	FLX380090B1026	51248220075
BMW 3-erSerie	E46	05/98-	FLX380090B1027	51248254261
BMW 3-erSerie	E46	05/98-	FLX380090B1028	51238202688
BMW 5-erSerie	E34	09/91-02/97	FLX380090B1029	51231944119
BMW 5-erSerie	E34	09/91-02/97	FLX380090B1030	51248149327
BMW 5-erSerie	E34	09/91-02/97	FLX380090B1031	51248230369
BMW 5-erSerie	E34	09/91-02/97	FLX380090B1032	51248149328
BMW 5-erSerie	E34	09/91-02/97	FLX380090B1033	51248230370
BMW 5-erSerie	E34	02/88-11/95	FLX380090B1034	51231944119
BMW 5-erSerie	E34	02/88-11/95	FLX380090B1035	51241934270
BMW 5-erSerie	E34	02/88-11/95	FLX380090B1036	51248110327
BMW 5-erSerie	E34	02/88-11/95	FLX380090B1037	51242231663
BMW 5-erSerie	E39	03/97-	FLX380090B1038	51248174866
BMW 5-erSerie	E39	03/97-	FLX380090B1039	51248190688
BMW 5-erSerie	E39	05/95-	FLX380090B1040	51238174866
BMW 5-erSerie	E39	09/91-05/96	FLX380090B1041	51248159239
BMW 5-erSerie	E39	05/96-	FLX380090B1042	51248222913



88 89 90 91 92 93
94 95 96 97 98 99
00 01 02 03 04 05
Çil / Year

Flexlift Ref. No.

OEM

BMW 6-erSerie	E24	05/79-04/89	FLX380090B1043	51231869147
BMW 7-erSerie	E23	09/86-06/94	FLX380090B1044	51231869147
BMW 7-erSerie	E32	09/86-06/94	FLX380090B1045	11811869147
BMW 7-erSerie	E32	09/86-06/94	FLX380090B1046	51231908465
BMW 7-erSerie	E32	09/86-06/94	FLX380090B1047	51241908431
BMW 7-erSerie	E38	06/94	FLX380090B1048	51238150077
BMW 7-erSerie	E38	06/94	FLX380090B1049	51248171480
BMW 7-erSerie	E65	09/01	FLX380090B1050	51238240596
CITROEN				
Citroen AX	ZA-	86-12/98	FLX380090C1001	95631956
Citroen AX	ZA-	86-12/98	FLX380090C1002	9563195680
Citroen Berlingo	MF-	07/96	FLX380090C1003	8731
Citroen BX	XB	08/85-11/94	FLX380090C1004	9560649080
Citroen BX	XB	01/82-10/86	FLX380090C1005	65568454
Citroen BX	XB	01/82-10/86	FLX380090C1006	9556845480
Citroen BX	XB	10/86-11/94	FLX380090C1007	956339888
Citroen BX	XB	10/86-11/94	FLX380090C1008	9563598880
Citroen BX	XBGT-Sport-IE	01/82-10/86	FLX380090C1009	95598526
Citroen BX	XRG-T-Sport-IE	01/82-10/86	FLX380090C1010	9559852680
Citroen BX	Turbo, 19TRS Athena, 19T2SIE	10/86-11/94	FLX380090C1011	95633989
Citroen BX	Turbo, 19TRS Athena, 19T2SIE	10/86-11/94	FLX380090C1012	9563598980
Citroen C5	C5	03/01	FLX380090C1013	8731F5
Citroen C5	C5	03/01	FLX380090C1014	8731F6
Citroen CX	MA	09/74-12/91	FLX380090C1015	5429798
Citroen CX	BreakMA	09/74-12/91	FLX380090C1016	5459705
Citroen CX	BreakMA	09/74-12/91	FLX380090C1017	5490307
Citroen Evasion	22.U6U	06/94-11/95	FLX380090C1018	8731A3
Citroen Evasion	22.U6U	11/95	FLX380090C1019	1479303080
Citroen Evasion	22.U6U	11/95	FLX380090C1020	5103300731CI
Citroen Saxo	SCSI	05/96-02/02	FLX380090C1021	8731CO
Citroen Saxo	S0.S1	05/96-02/02	FLX380090C1022	9618119100
Citroen Visa	Visa	01/83-89	FLX380090C1023	9558825480
Citroen Xantia	XI	06/95-01/98	FLX380090C1024	620915680
Citroen Xantia	XI	06/95-01/98	FLX380090C1025	8731A8
Citroen Xantia	XI	06/95-01/98	FLX380090C1026	C101860033
Citroen Xantia	XI	07/93-01/98	FLX380090C1027	8731C2
Citroen Xantia	XI	07/93-01/98	FLX380090C1028	8731C3
Citroen Xantia	XI	07/93-01/98	FLX380090C1029	949901
Citroen Xantia	XI	07/93-01/98	FLX380090C1030	873196
Citroen Xantia	XI	07/93-01/98	FLX380090C1031	873197
Citroen Xantia	X2	01/98-09/01	FLX380090C1032	620915680
Citroen Xantia	X2	01/98-09/01	FLX380090C1033	8731A8
Citroen Xantia	X2	01/98-09/01	FLX380090C1034	C101860033
Citroen Xantia	X2	01/98-09/01	FLX380090C1035	8731C2
Citroen Xantia	X2	01/98-09/01	FLX380090C1036	9626058680
Citroen Xantia	X2	01/98-09/01	FLX380090C1037	8731C3
Citroen XM	Y3.Y4	01/90-12/99	FLX380090C1038	9563914480
Citroen XM	Y3.Y4	01/92-12/99	FLX380090C1039	9602964
Citroen XM	Y3.Y4	01/90-12/00	FLX380090C1040	9563914480
Citroen XM	Y3.Y4	01/90-12/00	FLX380090C1041	96095456
Citroen Xsara	NI	04/97	FLX380090C1042	792511
Citroen Xsara	NI	04/97	FLX380090C1043	9629618980
Citroen Xsara	NI	04/97	FLX380090C1044	8731000
Citroen Xsara	NI	04/97	FLX380090C1045	9621907680
Citroen Xsara	N2	10/97	FLX380090C1046	792511
Citroen Xsara	N2	10/97	FLX380090C1047	9629618980
Citroen Xsara	N2	10/97	FLX380090C1048	87310000
Citroen Xsara	N2	10/97	FLX380090C1049	9620677480
Citroen Xsara Picasso	N68	12/99	FLX380090C1050	792511
Citroen Xsara Picasso	N68	12/99	FLX380090C1051	9629618980
Citroen Xsara Picasso	N68	12/99	FLX380090C1052	8731F1
Citroen ZX	N2	09/91-06/97	FLX380090C1053	9612361280
Citroen ZX	N2	09/91-06/97	FLX380090C1054	960275443
Citroen ZX	N2	09/91-06/97	FLX380090C1055	9602754380
Citroen ZX	N2	10/93-03/98	FLX380090C1056	9612221280
DAEWOO				
Lanos	KLAT	05/97	FLX380090D1001	96306157
Matiz	KLVA	09/98	FLX380090D1002	96563503
Nubira	KLAJ	05/97	FLX380090D1003	96301822
Tacuma	KLAU		FLX380090D1004	96394240
FIAT				
Fiat Brava	182	10/95-06/00	FLX380090F1001	77697370
Fiat Brava	182	10/95-06/00	FLX380090F1002	77747070
Fiat Bravo	182	07/00-10/01	FLX380090F1003	77747070
Fiat Cinquecento	170	12/91-01/98	FLX380090F1004	46453503
Fiat Cinquecento	170	12/91-01/98	FLX380090F1005	76349470
Fiat Croma	154	12/85-12/96	FLX380090F1006	725511780



88 89 90 91 92 93
94 95 96 97 98 99
00 01 02 03 04 05
Çil / Year

Flexlift Ref. No.

OEM

Fiat Croma	154	12/85-12/96	FLX380090F1007	824296860
Fiat Dukka	223	03/01	FLX380090F1008	46824070
Fiat Duna	146B	01/87-12/91	FLX380090F1009	7516691
Fiat Mareta	Weekend 185	05/96	FLX380090F1010	46420780
Fiat Multipla	186	04/99	FLX380090F1011	46514867
Fiat Palio	Palio	04/96	FLX380090F1012	46530124
Fiat Palio	Weekend 178DX	04/96	FLX380090F1013	46524047
Fiat Panda	141A-	05/80-09/86	FLX380090F1014	39661920
Fiat Panda	141A-	05/80-09/86	FLX380090F1015	44836580
Fiat Panda	Restyling 141 A-Vet.6314421,5370347	10/86-12/96	FLX380090F1016	39661920
Fiat Panda	Restyling 141 A-Vet.6314421,5370347	10/86-12/96	FLX380090F1017	44836580
Fiat Panda	Restyling 141 A-Vet.6314422,5370348	10/86-12/96	FLX380090F1018	75501720
Fiat Punto	Cabriolet 76CVet,9659	04/94-08/99	FLX380090F1019	46730250
Fiat Punto	Cabriolet 76CVet,9659	04/94-08/99	FLX380090F1020	46730681C3
Fiat Punto	1176	09/93-08/99	FLX380090F1021	77345660
Fiat Punto	11188	05/99	FLX380090F1022	46744596
Fiat Punto	11188	05/99	FLX380090F1023	46744596
Fiat Punto	11188	05/99	FLX380090F1024	46524678
Fiat Punto	11188	05/99	FLX380090F1025	46524678
Fiat Regata	Weekend	03/85-12/89	FLX380090F1026	59851660
Fiat Ritmo	192	10/01	FLX380090F1027	46784994
Fiat Tempra	StationWagon59	01/98-08/97	FLX380090F1028	76063040
Fiat Tipo	160	88-24/95	FLX380090F1029	76717000
Fiat Ulysse	220	06/94-11/95	FLX380090F1030	8731A3
Fiat Ulysse	220	11/95-08/02	FLX380090F1031	1479303080
Fiat Ulysse	220	11/95-08/02	FLX380090F1032	51023300
Fiat Ulysse	220	11/95-08/02	FLX380090F1033	8731C1
Fiat Ulysse	220	08/02	FLX380090F1034	1489342080
Fiat Uno	146A	01/83-89	FLX380090F1035	487670
Fiat Uno	146A	01/83-89	FLX380090F1036	59035420
Fiat Uno	146A Restyling	89-12/93	FLX380090F1037	76360490
Fiat Uno	146ATurbo	04/85-89	FLX380090F1038	7571080
FORD				
Ford Escort	MkIIIV	07/80-07/90	FLX380090F2001	86ABW406A10CA
Ford Escort	MkIIIV	07/80-07/90	FLX380090F2002	86ABW406A10GA
Ford Escort	MkIIIV	07/80-07/90	FLX380090F2003	86ABW406A10GA
Ford Escort	MkV	08/90-05/92	FLX380090F2004	6656800
Ford Escort	MkV	08/90-05/92	FLX380090F2005	6885988
Ford Escort	MkV	08/90-05/92	FLX380090F2006	91ABW406A10A1C
Ford Escort	MkV	08/90-05/92	FLX380090F2007	91ABW406A10AF
Ford Escort	MkV	08/90-05/92	FLX380090F2008	91ABW406A10AG
Ford Escort	MkV	08/90-05/92	FLX380090F2009	91ABA406A10C1
Ford Escort	MkV	08/90-05/92	FLX380090F2010	91ABA406A10A1D
Ford Escort	MkV	08/90-05/92	FLX380090F2011	91ABA406A10A1E
Ford Escort	MkVI.VII	05/92-09/00	FLX380090F2012	93ABA406A10B1B
Ford Escort	MkVI.VII	05/92-09/00	FLX380090F2013	6723080
Ford Escort	MkVI.VII	05/92-09/00	FLX380090F2014	6900217
Ford Escort	MkVI.VII	05/92-09/00	FLX380090F2015	91ABA406A10C1E
Ford Escort	MkVI.VII	05/92-09/00	FLX380090F2016	93ABA406A10C1B
Ford Escort	MkVI.VII	05/92-09/00	FLX380090F2017	6556800
Ford Escort	MkVI.VII	05/92-09/00	FLX380090F2018	6885988
Ford Escort	MkVI.VII	05/92-09/00	FLX380090F2019	91ABW406A10A1C
Ford Escort	MkVI.VII	05/92-09/00	FLX380090F2020	91ABW406A10AF
Ford Escort	MkVI.VII	05/92-09/00	FLX380090F2021	91ABW406A10AG
Ford Escort	XB3RC-Turbo	02/86-89	FLX380090F2022	84C8B06A10A
Ford Escort	XR3RS-Turbo	01/89-07/90	FLX380090F2023	89ABW406A10HA
Ford Fiesta	MkII	08/83-03/89	FLX380090F2024	84FBW406A10DB
Ford Fiesta	MkII	08/83-03/89	FLX380090F2025	84FBW406A10DB
Ford Fiesta	MkIII	03/89-04/93	FLX380090F2026	89FBW406A10B1C
Ford Fiesta	MkIII	04/93-03/96	FLX380090F2027	93FBW406A10BA
Ford Fiesta	MkIII	03/89-04/93	FLX380090F2028	89FBW406A10A1C
Ford Fiesta	MkIII	04/93-03/96	FLX380090F2029	93FBW406A10AA
Ford Fiesta	MkIV	01/96-10/01	FLX380090F2030	10082776
Ford Fiesta	MkIV	01/96-10/01	FLX380090F2031	10082777
Ford Fiesta	MkIV	01/96-10/01	FLX380090F2032	96FBW406A10AA
Ford Fiesta	MkIV	01/96-10/01	FLX380090F2033	96FBW406A10BA
Ford Fiesta	V	11/01-11/02	FLX380090F2034	11411559
Ford Fiesta	V	11/01-11/02	FLX380090F2035	2561A406A10AB
Ford Fiesta	V	06/02	FLX380090F2036	1211497
Ford Fiesta	V	06/02	FLX380090F2037	2N11N406A10AD
Ford Focus	DAW.DBW	10/98-12/00	FLX380090F2038	1070024
Ford Focus	DAW.DBW	10/98-12/00	FLX380090F2039	1074368
Ford Focus	DAW.DBW	10/98-12/00	FLX380090F2040	1150277
Ford Focus	DAW.DBW	10/98-12/00	FLX380090F2041	X541A06A10AE
Ford Focus	DAW.DBW	10/98-12/00	FLX380090F2042	X541A06A10AF
Ford Focus	DAW.DBW	12/00	FLX380090F2043	1150277
Ford Focus	DAW.DBW	12/00	FLX380090F2044	1150279



88 89 90 91 92 93
94 95 96 97 98 99
00 01 02 03 04 05
Yıl / Year

Flexlift Ref. No.

OEM

Ford Focus	DAW,DBW	12/00-	FLX38009F2045	X541A405A10AF
Ford Focus	UAW,U8W	11/01-04/02	FLX48009F2046	1130277
Ford Focus	DAW,DBW	11/01-04/02	FLX38009F2047	2M51A406A10AA
Ford Focus	DAW,DBW	11/01-04/02	FLX38009F2048	X541A405A10AF
Ford Focus	DFW	11/98-05/99	FLX38009F2049	1071732
Ford Focus	DFW	11/98-05/99	FLX38009F2050	1072394
Ford Focus	DFW	11/98-05/99	FLX38009F2051	1092108
Ford Focus	DFW	11/98-05/99	FLX38009F2052	1114031
Ford Focus	DFW	11/98-05/99	FLX38009F2053	X541F406A10AC
Ford Focus	DFW	11/98-05/99	FLX38009F2054	X541F406A10AD
Ford Focus	DFW	11/98-05/99	FLX38009F2055	X541F406A10AE
Ford Focus	DFW	05/99-10/01	FLX38009F2056	1092108
Ford Focus	DFW	05/99-10/01	FLX38009F2057	1114031
Ford Focus	DFW	05/99-10/01	FLX38009F2058	X541F406A10AD
Ford Focus	DFW	05/99-10/01	FLX38009F2059	X541F406A10AE
Ford Focus	DFW	10/01-	FLX38009F2060	1124003
Ford Focus	DFW	10/01-	FLX38009F2061	X541F406A10AF
Ford Focus	KombiDNN	11/98-01/01	FLX38009F2062	1071669
Ford Focus	KombiDNN	11/98-01/01	FLX38009F2063	1079800
Ford Focus	KombiDNN	11/98-01/01	FLX38009F2064	1093705
Ford Focus		11/98-01/01	FLX38009F2065	X541N406A10AD
Ford Focus		11/98-01/01	FLX38009F2066	X541N406A10AE
Ford Focus	KombiDNN	01/01-07/01	FLX38009F2067	1136483
Ford Focus	KombiDNN	01/01-07/01	FLX38009F2068	1146649
Ford Focus		01/01-07/01	FLX38009F2069	X541N406A10AH
Ford Focus		01/01-07/01	FLX38009F2070	X541N406A10AJ
Ford Focus	KombiDNN	07/01-	FLX38009F2071	1146649
Ford Focus	KombiDNN	07/01-	FLX38009F2072	X541N406A10AJ
Ford Focus	JU-	08/02-	FLX38009F2073	1212386
Ford Focus	JU	08/02-	FLX38009F2074	2N11N406A10AD
Ford Galaxy	WGR	06/95-	FLX38009F2075	1099960
Ford Galaxy	WGR	06/95-	FLX38009F2076	1047112
Ford Galaxy	WGR	06/95-	FLX38009F2077	1094814
Ford Galaxy	WGR	06/95-	FLX38009F2078	7300969
Ford Galaxy	WGR	06/95-	FLX38009F2079	95VW44J20BAE
Ford Galaxy	WGR	06/95-	FLX38009F2080	95VW44J20BAB
Ford Galaxy	WGR	06/95-	FLX38009F2081	95VW44J20BAC
Ford Ka	BBT	09/96-	FLX38009F2082	97KGB406A10AA
Ford Mondeo	Mondeo I	02/93-08/96	FLX38009F2083	93BBF406A10AB
Ford Mondeo	Mondeo I	02/93-08/96	FLX38009F2084	93BBF406A10BB
Ford Mondeo	Mondeo I	02/93-08/96	FLX38009F2085	93BBA406A10AD
Ford Mondeo	Mondeo I	02/93-08/96	FLX38009F2086	93BBA406A10AE
Ford Mondeo	Mondeo II	08/96-11/00	FLX38009F2087	93BBF406A10AB
Ford Mondeo	Mondeo II	08/96-11/00	FLX38009F2088	93BBA406A10BD
Ford Mondeo	Mondeo III	08/96-11/00	FLX38009F2089	93BBF406A10BD
Ford Mondeo	Mondeo III	11/00-	FLX38009F2090	1117690
Ford Mondeo	Mondeo III	11/00-	FLX38009F2091	1120812
Ford Mondeo	Mondeo III	11/00-	FLX38009F2092	157116C526AD
Ford Mondeo	Mondeo III	11/00-	FLX38009F2093	1117246
Ford Mondeo	Mondeo III	11/00-	FLX38009F2094	1571F406A10AB
Ford Mondeo	Mondeo III	11/00-	FLX38009F2095	1117046
Ford Mondeo	Mondeo III	11/00-	FLX38009F2096	1571A406A10AC
Ford Mondeo	Mondeo III	11/00-	FLX38009F2097	1117394
Ford Mondeo	Mondeo III	11/00-	FLX38009F2098	1571N406A10AB
Ford Mondeo	Kombi	02/93-08/96	FLX38009F2099	93BBN406A10AC
Ford Mondeo	Kombi	08/96-11/00	FLX38009F2100	93BBN406A10AC
Ford Puma	ECT	03/97-02/99	FLX38009F2101	1034930
Ford Puma	ECT	03/97-02/99	FLX38009F2102	1088369
Ford Puma	ECT	03/97-02/99	FLX38009F2103	V97FBC406A10AB
Ford Puma	ECT	03/97-02/99	FLX38009F2104	V97FBC406A10AC
Ford Puma	ECT	02/99-06/02	FLX38009F2105	1088369
Ford Puma	ECT	02/99-06/02	FLX38009F2106	V97FBC406A10AC
Ford Puma	ECT	06/02-	FLX38009F2107	1088369
Ford Puma	ECT	06/02-	FLX38009F2108	V97FBC406A10AC
Ford Puma	ECT	06/02-	FLX38009F2109	1121248
Ford Puma	ECT	06/02-	FLX38009F2110	1N31C406A10AB
Ford Scorpio	IGhia	01/85-09/94	FLX38009F2111	85GBA406A10CD
Ford Scorpio	IL/GL	01/85-09/94	FLX38009F2112	85GBA406A10BD
Ford Scorpio	IL/GL/Ghia	01/85-09/94	FLX38009F2113	85GBA406A10DD
Ford Scorpio	Scorpio 1.11	01/92-09/94	FLX38009F2114	1666983
Ford Scorpio	Scorpio 1.11	01/92-09/94	FLX38009F2115	6186916
Ford Scorpio	Scorpio 1.11	01/92-09/94	FLX38009F2116	6962811
Ford Scorpio	Scorpio 1.11	01/92-09/94	FLX38009F2117	96GBN405A10AF
Ford Scorpio	Scorpio II	10/94-08/98	FLX38009F2118	1666983
Ford Scorpio	Scorpio II	10/94-08/98	FLX38009F2119	6186916
Ford Scorpio	Scorpio II	10/94-08/98	FLX38009F2120	6962811
Ford Scorpio	Scorpio II	10/94-08/98	FLX38009F2121	96GBN405A10AF
Ford Scorpio	Scorpio II	10/94-08/98	FLX38009F2122	6742355



88 89 90 91 92 93
94 95 96 97 98 99
00 01 02 03 04 05
Yıl / Year

Flexlift Ref. No.

OEM

Ford Scorpio	Scorpio II	10/94-08/98	FLX38009F2123	6797888
Ford Scorpio	Scorpio II	10/94-08/98	FLX38009F2124	6876381
Ford Scorpio	Scorpio II	10/94-08/98	FLX38009F2125	6962810
Ford Scorpio	Scorpio II	10/94-08/98	FLX38009F2126	90GBF406A10AA
Ford Scorpio	Scorpio II	10/94-08/98	FLX38009F2127	90GBF406A10AB
Ford Scorpio	Scorpio II	10/94-08/98	FLX38009F2128	7245797
Ford Scorpio	Scorpio II	10/94-08/98	FLX38009F2129	95GB16C826AB
Ford Sierra	LGL,GHIA	08/82-02/93	FLX38009F2130	83BBA406A10BD
Ford Sierra	LGL,GHIA	08/82-02/93	FLX38009F2131	83BBA406A10AD
Ford Sierra	RS	03/87-02/93	FLX38009F2132	83BBA406A10CD
Ford Sierra	RS	03/87-02/93	FLX38009F2133	88BBA406A10BAD
Ford Sierra	Sport	08/82-02/93	FLX38009F2134	86BBA406A10BA
Ford Sierra	Sport	08/88-02/93	FLX38009F2135	88BBA406A10AA
Ford Sierra	Turnier	08/82-02/93	FLX38009F2136	83BBA406A10BB
Ford Sierra	Turnier	08/82-02/93	FLX38009F2137	83BBA406A10AB
Ford Sierra	XR4i	08/82-02/87	FLX38009F2138	83BBA406A10CD
Ford Sierra	XR4i	08/82-02/87	FLX38009F2139	88BBA406A10BAD
Ford Transit	Transit	09/85-07/91	FLX38009F2140	86VBV406A10CA
Ford Transit	Transit	09/85-07/91	FLX38009F2141	86VBV406A10BA
HONDA				
Honda Civic	Civic V	01/97-	FLX38009H1001	7482053E010
Honda Civic	Civic V	01/97-	FLX38009H1002	7482053E02
Honda Civic	Civic V	01/97-	FLX38009H1003	7482053E010
Honda Civic	Civic V	01/97-	FLX38009H1004	7482053E02
Honda Civic	Civic V	01/97-	FLX38009H1005	7482053E010
Honda Civic	Civic V	01/97-	FLX38009H1006	7482053E02
Honda Civic	Civic V	01/97-	FLX38009H1007	7482053E010
Honda Civic	Civic V	01/97-	FLX38009H1008	7482053E02
Honda Concerto	Concerto	10/90-03/95	FLX38009H1009	BHE38025
Honda Concerto	Concerto	10/90-03/95	FLX38009H1010	GST 120
Honda Concerto	Concerto	10/90-03/95	FLX38009H1011	BHE38017
Honda Concerto	Concerto	10/90-03/95	FLX38009H1012	GST 122
HYUNDAI				
Hyundai Accent	Accent X-3	10/94-01/00	FLX38009H2001	8177022200
Hyundai Accent	Accent X-3	10/94-01/00	FLX38009H2002	8178022200
Hyundai Accent	Accent X-3	10/94-01/00	FLX38009H2003	8177025200
Hyundai Accent	Accent X-3	10/94-01/00	FLX38009H2004	8178025200
Hyundai Atos	Atos MX	02/98-03/01	FLX38009H2005	8177002010
Hyundai Atos	Atos MX	02/98-03/01	FLX38009H2006	8178002010
Hyundai Atos	Atos PrimeMX	08/99-	FLX38009H2007	8177006000
Hyundai Atos	Atos PrimeMX	08/99-	FLX38009H2008	8178006000
Hyundai Coupe	Coupe RD	06/96-04/02	FLX38009H2009	8177027011
Hyundai Lantra	Lantra J2	11/95-09/00	FLX38009H2010	8,1771E+215
Hyundai Lantra	Lantra J2/Wagon	03/06-	FLX38009H2011	8177130211
LADA				
Niva 1600			FLX38009L1001	21210630801000A
Niva 1700			FLX38009L1002	21213821301000A
Lada Samara	2108	07/86-03/99	FLX38009L1003	21086308010
LANCIA				
Lancia Dedra	835	01/89-07/99	FLX38009L2001	824372560
Lancia Delta	Delta I	09/79-05/93	FLX38009L2002	823366870
Lancia Delta	Delta II	05/93-02/95	FLX38009L2003	82473205
Lancia Delta	Delta II	03/95-	FLX38009L2004	464337020
Lancia Delta	Delta II Sport	05/93-02/95	FLX38009L2005	824597740
Lancia Nuova	Delta	05/93-	FLX38009L2006	464247270
Lancia Phedra	179	05/02-	FLX38009L2007	1489342080
Lancia Prisma	831AB	03/83-06/89	FLX38009L2008	823804530
Lancia Thema	StationWagon834	09/87-03/95	FLX38009L2009	5893903
Lancia Thema	StationWagon834	09/87-03/95	FLX38009L2010	6203470110
Lancia Thema	StationWagon834	09/87-03/95	FLX38009L2011	82430553
Lancia Thema	StationWagon834	09/87-03/95	FLX38009L2012	5893907
Lancia Thema	StationWagon834	09/87-03/95	FLX38009L2013	6203470010
Lancia Thema	StationWagon834	09/87-03/95	FLX38009L2014	82430552
Lancia Y10	156	03/85-10/95	FLX38009L2015	60617400
Lancia Y10	156	04/95-	FLX38009L2016	60617400
Lancia Y10	156	04/95-	FLX38009L2017	77033250
Lancia Y1 1	840A-Ypsilon	04/95-07/00	FLX38009L2018	77929510
Lancia Y1 1	840A-Ypsilon	08/00-	FLX38009L2019	77929510
Lancia Zeta	220	05/95-11/95	FLX38009L2020	8731 A3
Lancia Zeta	220	11/95-	FLX38009L2021	1479303080
Lancia Zeta	220	11/95-	FLX38009L2022	51023300
Lancia Zeta	220	11/95-	FLX38009L2023	8731C1
MERCEDES				
190/190E	W201	10/82-08/93	FLX38009M1001	9802464
190/190E	W201	10/82-08/93	FLX38009M1002	9802564
190/190E	W201	10/82-08/93	FLX38009M1003	9803764



88 89 90 91 92 93
94 95 96 97 98 99
00 01 02 03 04 05
Çi / Year

Flexlift Ref. No.

OEM

190/190E	W201	10/82-08/93	FLX380090M1004	201880229
190U/190E	W201	10/84-08/93	FLX380090M1005	201880329
200T-320TE	T124Kombi	10/85-05/96	FLX380090M1006	1249800164
200T-320TE	T124Kombi	10/85-05/96	FLX380090M1007	1249800264
A Klasse	W168	07/97-	FLX380090M1008	1689800164
A Klasse	W168	07/97-	FLX380090M1009	1689800964
C Klasse	T202Kombi	03/96-03/01	FLX380090M1010	202880029
C Klasse	T202Kombi	03/96-03/01	FLX380090M1011	2029800364
C Klasse	W202	06/93-08/00	FLX380090M1012	202880029
E Klasse	T210Kombi	06/96-	FLX380090M1013	19808064
E Klasse	W/T210	05/95-	FLX380090M1014	2108800229
E Klasse	W/T210		FLX380090M1015	2108800429

NISSAN

Nissan Almera	TinoVO	08/00-	FLX380090N1001	904508U000
Nissan Almera	TinoVO	08/00-	FLX380090N1002	904518U000
Nissan Forklift Truck	ForkliftTruck	90-	FLX380090N1003	6532005K00
Nissan Forklift Truck	ForkliftTruck	90-	FLX380090N1004	6532031K00
Nissan Forklift Truck	ForkliftTruck	90-	FLX380090N1005	6532005K00
Nissan Forklift Truck	ForkliftTruck	90-	FLX380090N1006	653201K60
Nissan Forklift Truck	ForkliftTruck	90-	FLX380090N1007	6532096200
Nissan Forklift Truck	ForkliftTruck	90-	FLX380090N1008	6532096200
Nissan Forklift Truck	ForkliftTruck	90-	FLX380090N1009	65320F4300
Nissan N01-MC	N01-MC		FLX380090N1010	6532036400
Nissan Patrol	Patrol	09/84-	FLX380090N1011	90451C9503
Nissan Patrol	Patrol	09/84-	FLX380090N1012	90450C9503
Nissan Primera	P10EC4	06/90-06/96	FLX380090N1013	8443050100
Nissan Primera	P10EC4	06/90-06/96	FLX380090N1014	8443050110
Nissan Primera	P10EC5	06/90-06/96	FLX380090N1015	904523F201
Nissan Primera	P10EC5	06/90-06/96	FLX380090N1016	904523F200
Nissan Primera	P10EC5	06/90-06/96	FLX380090N1017	904523F202
Nissan Primera	P10EC5	06/90-06/96	FLX380090N1018	904525A26
Nissan Primera	P11EQ4	06/96-	FLX380090N1019	844302F010
Nissan Primera	P11EQ4	06/96-	FLX380090N1020	844302F000
Nissan Primera	P11EQ5	06/96-	FLX380090N1021	904522F705
Nissan Primera	P11EQ5	06/96-	FLX380090N1022	904522F725
Nissan Primera	P11EQ5	06/96-	FLX380090N1023	904526F100
Nissan Primera	P11EQ5	06/96-	FLX380090N1024	904522F715
Nissan Primera	P11EQ5	06/96-	FLX380090N1025	904526F126
Nissan Safari	Safari	09/84-	FLX380090N1026	90451C9503
Nissan Safari	Safari	09/84-	FLX380090N1027	90450C9503
Nissan Serena	C23ML	07/92-	FLX380090N1028	904519C102
Nissan Serena	C23ML	07/92-	FLX380090N1029	904509C102
Nissan Serena	C23ML	07/92-	FLX380090N1030	904509C102
Nissan Serena	C23MLX	07/92-	FLX380090N1031	904519C004
Nissan Serena	C23MLX	07/92-	FLX380090N1032	904509C004
Nissan Serena	C23MLX	07/92-	FLX380090N1033	904509C004
Nissan Serena	C23MSGX SLX	07/92-	FLX380090N1034	904519C005
Nissan Serena	C23MSGX SLX	07/92-	FLX380090N1035	904519C005
Nissan Serena	C23MSGX SLX	07/92-	FLX380090N1036	904509C005
Nissan Serena	C23MSGX SLX	07/92-	FLX380090N1037	904509C005
Nissan Truck	TK22		FLX380090N1038	654709K002

OPEL

Opel Agila	H00	04/00-	FLX380090O1001	4705437
Opel Agila	H00	04/00-	FLX380090O1002	4705436
Opel Astra	F	09/91-01/98	FLX380090O1003	90341282
Opel Astra	FCaravan	09/91-01/98	FLX380090O1004	90341378
Opel Astra	FCaravan	09/91-01/98	FLX380090O1005	90341377
Opel Astra	G	01/98-	FLX380090O1006	132677
Opel Astra	G	01/98-	FLX380090O1007	90521517
Opel Astra	G	01/98-	FLX380090O1008	132741
Opel Astra	G	01/98-	FLX380090O1009	24411022
Opel Astra	GCaravan	01/98-	FLX380090O1010	132739
Opel Astra	GCaravan	01/98-	FLX380090O1011	90559245
Opel Calibra	A	03/90-08/97	FLX380090O1012	132717
Opel Calibra	A	03/90-08/97	FLX380090O1013	90346469
Opel Corsa	ATR_SR	09/82-03/93	FLX380090O1014	132713
Opel Corsa	ATR_SR	09/82-03/93	FLX380090O1015	90127137
Opel Corsa	ATR_SR	09/82-03/93	FLX380090O1016	90138F17
Opel Corsa	ATR_SR	09/82-03/93	FLX380090O1017	90127136
Opel Corsa	B	03/93-09/00	FLX380090O1018	90481270
Opel Corsa	B	03/93-09/00	FLX380090O1019	90481269
Opel Corsa	B	03/93-09/00	FLX380090O1020	90388707
Opel Corsa	C	09/00-	FLX380090O1021	91143111
Opel Corsa	C	09/00-	FLX380090O1022	132670
Opel Corsa	C	09/00-	FLX380090O1023	132671
Opel Kadett	DE5007044.E2544950.E6002381	08/79-08/84	FLX380090O1024	132685
Opel Kadett	DE5007044.E2544950.E6002381	08/79-08/84	FLX380090O1025	90068230



88 89 90 91 92 93
94 95 96 97 98 99
00 01 02 03 04 05
Çi / Year

Flexlift Ref. No.

OEM

Opel Kadett	E	09/84-08/91	FLX380090O1026	90159607
Opel Kadett	E	09/84-08/91	FLX380090O1027	9019167
Opel Kadett	E	09/84-08/91	FLX380090O1028	90191920
Opel Kadett	ECaravan	09/84-08/87	FLX380090O1029	90159629
Opel Kadett	ECaravan	08/87-08/91	FLX380090O1030	90241996
Opel Kadett	ECaravan	09/84-08/87	FLX380090O1031	90196023
Opel Kadett	ECaravan	08/87-08/91	FLX380090O1032	90241995
Opel Omega	A	01/86-01/91	FLX380090O1033	90275080
Opel Omega	A	01/91-02/94	FLX380090O1034	90275102
Opel Omega	ACaravan	01/86-02/94	FLX380090O1035	90246620
Opel Omega	ACaravan	01/86-02/94	FLX380090O1036	90246621
Opel Omega	B	-02/94-	FLX380090O1037	90379054
Opel Omega	BCh.X1999999	02/94-07/98	FLX380090O1038	1180401
Opel Omega	BCh.X1999999	02/94-07/98	FLX380090O1039	90379025
Opel Omega	BCh.Y1000001	08/98-	FLX380090O1040	9146281
Opel Omega	BCh.Y1000001	08/98-	FLX380090O1041	1180403
Opel Omega	BCaravan	02/94-	FLX380090O1042	132675
Opel Omega	BCaravan	02/94-	FLX380090O1043	90379081
Opel Senator	Senator B	-01/9103	FLX380090O1044	90275080
Opel Sintra	Sintra	11/96-04/99	FLX380090O1045	10233373
Opel Sintra	Sintra	11/96-04/99	FLX380090O1046	10400854
Opel Sintra	Sintra	11/96-04/99	FLX380090O1047	1,32729E+11
Opel Sintra	Sintra	11/96-04/99	FLX380090O1048	132736
Opel Vectra	A	04/88-09/95	FLX380090O1049	90227936
Opel Vectra	ACoupe	91-99/95	FLX380090O1050	90227934
Opel Vectra	ACoupe	91-99/95	FLX380090O1051	90227934
Opel Vectra	B	10/95-04/02	FLX380090O1052	1180402
Opel Vectra	B	10/95-04/02	FLX380090O1053	90463721
Opel Vectra	BCh. W1999999.W5999999.W7999999	10/95-07/98	FLX380090O1054	132727
Opel Vectra	BCh.W1999999.W5999999.W7999999		FLX380090O1055	90463740
Opel Vectra	BCh.X1000001.X7000001	08/98-04/02	FLX380090O1056	1,32682E+12
Opel Vectra	BKombi	10/95-04/02	FLX380090O1057	132731
Opel Vectra	BKombi	10/95-04/02	FLX380090O1058	90463761
Opel Zafira	F75-	01/99-	FLX380090O1059	132742
Opel Zafira	F75-	01/99-	FLX380090O1060	90579440

PEUGEOT

Peugeot 106	IIA.1C	01/91-04/96	FLX380090P1001	873185
Peugeot 106	IIA.1C	01/91-04/96	FLX380090P1002	873186
Peugeot 106	IIA.1C	01/91-04/96	FLX380090P1003	9605478880
Peugeot 106	IIA.1C	01/91-04/96	FLX380090P1004	9605478888
Peugeot 106	II	05/96-	FLX380090P1005	873191
Peugeot 205	Cabrio20D	03/86-09/94	FLX380090P1006	873170
Peugeot 205	I&II741A/C20A/C	02/82-07/96	FLX380090P1007	873155
Peugeot 205	I&II741A/C20A/C	02/82-07/96	FLX380090P1008	9614158880
Peugeot 205	I&II741A/C20A/C	02/82-07/96	FLX380090P1009	9629736780
Peugeot 205	I&II741A/C20A/C	02/82-07/96	FLX380090P1010	9656119680
Peugeot 206	206	05/98-	FLX380090P1011	51023704
Peugeot 206	206	05/98-	FLX380090P1012	8731000000
Peugeot 306	7A.7C	06/94-04/01	FLX380090P1013	873193
Peugeot 306	7A.7C	06/94-04/01	FLX380090P1014	9610016680
Peugeot 306	7A.7C	06/94-04/01	FLX380090P1015	9619988380
Peugeot 306	7B	06/94-04/01	FLX380090P1016	8731A2
Peugeot 306	7B	06/94-04/01	FLX380090P1017	9617046480
Peugeot 306	7EBreak	05/97-04/01	FLX380090P1018	87310
Peugeot 307	307	08/00-	FLX380090P1019	9624490960
Peugeot 309	HOA.10C	10/85-12/89	FLX380090P1020	792515
Peugeot 309	HOA.10C	10/85-12/89	FLX380090P1021	873169
Peugeot 309	HOA.10C	10/85-12/89	FLX380090P1022	9753100980
Peugeot 309	HOA.10C	10/85-12/89	FLX380090P1023	873165
Peugeot 309	HOA.10C1.96G	10/85-12/89	FLX380090P1024	9753100880
Peugeot 309	HOA.10C1.96G	10/85-12/89	FLX380090P1025	9753547180
Peugeot 309	HOA.10C1.96G	10/85-12/89	FLX380090P1026	9753547080
Peugeot 309	IIA.3C	07/89-07/93	FLX380090P1027	873178
Peugeot 309	IIA.3C	07/89-07/93	FLX380090P1028	9603762280
Peugeot 309	IIA.3C1.96G	07/89-07/93	FLX380090P1029	873179
Peugeot 309	IIA.3C1.96G	07/89-07/93	FLX380090P1030	9603762380
Peugeot 405	15E.4EBreak	10/88-10/96	FLX380090P1031	873183
Peugeot 405	15E.4EBreak	10/88-10/96	FLX380090P1032	9601404080
Peugeot 405	15E.4EBreak	10/88-10/96	FLX380090P1033	9612504980
Peugeot 406	08112	10/95-12/98	FLX380090P1034	8731A7
Peugeot 406	08112	10/95-12/98	FLX380090P1035	9616784580
Peugeot 406	08112	10/95-12/98	FLX380090P1036	9624536580
Peugeot 406	08112	1C/96-	FLX380090P1037	2870400
Peugeot 406	08112	1C/96-	FLX380090P1038	792507
Peugeot 406	08112	1C/96-	FLX380090P1039	9628157780
Peugeot 406	08112	1C/96-	FLX380090P1040	9630662480
Peugeot 406	08112	1C/96-	FLX380090P1041	8731C5



88 89 90 91 92 93
94 95 96 97 98 99
00 01 02 03 04 05
4 yıl / Year

Flexlift Ref. No.

OEM

Peugeot 406		10/96-	FLX38009P1042	9626711680
Peugeot 406		10/95-	FLX38009P1043	28 /0400
Peugeot 406		10/95-	FLX38009P1044	792507
Peugeot 406		10/95-	FLX38009P1045	9628157780
Peugeot 406		10/95-	FLX38009P1046	9630662480
Peugeot 406	Coupe	03/97-	FLX38009P1047	2870400
Peugeot 406	Coupe	03/97-	FLX38009P1048	792507
Peugeot 406	Coupe	03/97-	FLX38009P1049	9630662480
Peugeot 406	Coupe	03/97-	FLX38009P1050	3470400
Peugeot 505	551A	07/83-09/92	FLX38009P1051	862214
Peugeot 505	551A	07/83-09/92	FLX38009P1052	9252344980
Peugeot 505	Break551D,551F	07/83-09/92	FLX38009P1053	873151
Peugeot 605	6B	01/94-12/98	FLX38009P1054	8731A1
Peugeot 605	6B	01/94-12/98	FLX38009P1055	9622166080
Peugeot 806	806 221 06944	06/94-11/95	FLX38009P1056	8731 A3
Peugeot 806	806 221 06944 07632	11/95-	FLX38009P1057	51023300
Peugeot 806	806 221 06944 07632	11/95-	FLX38009P1058	8731C1
Peugeot 806	806 221 06944 07632	11/95-	FLX38009P1059	87310000
Peugeot Partner	SF	06/96-	FLX38009P1060	8731

RENAULT

Renault Clio	IB57-C57-	01/91-08/98	FLX38009R1001	7700272026
Renault Clio	IB57-C57-	01/91-08/98	FLX38009R1002	7700803111
Renault Clio	IB57-,C57-Baccara,Elke,Williams	01/91-08/98	FLX38009R1003	7700810554
Renault Clio	IIB/C/CB/SB0-	08/98-	FLX38009R1004	7700842256
Renault Espace	UII	12/84-12/87	FLX38009R1005	6025001817
Renault Espace	UII	12/84-12/87	FLX38009R1006	6025003039
Renault Espace	UII	12/84-12/87	FLX38009R1007	6025001818
Renault Espace	UII	12/84-12/87	FLX38009R1008	6025003038
Renault Espace	UII	01/88-03/91	FLX38009R1009	6025009335
Renault Espace	UII	01/88-03/91	FLX38009R1010	6025006621
Renault Espace	UII	12/84-03/91	FLX38009R1011	6025001088
Renault Espace	UII	12/84-03/91	FLX38009R1012	6025003919
Renault Espace	IU63	04/91-11/93	FLX38009R1013	6025101952
Renault Espace	IU63	11/93-11/96	FLX38009R1014	6025106762
Renault Espace	IU63	04/91-11/96	FLX38009R1015	6025100991
Renault Espace	HUE	11/96-	FLX38009R1016	6025305563
Renault Espace	HUE	11/96-	FLX38009R1017	6025305941
Renault Espace	HUE	11/96-	FLX38009R1018	6025307035
Renault Express/Rapid	F40	07/85-03/98	FLX38009R1019	7700807057
Renault GrandEspace	HUE	11/96-	FLX38009R1020	6025305563
Renault GrandEspace	HUE	11/96-	FLX38009R1021	6025305941
Renault Kangoo	KC0-	03/98-	FLX38009R1022	7700303139
Renault Kangoo	KC0-	03/98-	FLX38009R1023	7700303186
Renault Kangoo	ExpressFCO-	03/98-	FLX38009R1024	7700303139
Renault Kangoo	ExpressFCO-	03/98-	FLX38009R1025	7700303186
Renault Laguna	IB56-	03/94-03/01	FLX38009R1026	7700823271
Renault Laguna	IB56-	03/94-03/01	FLX38009R1027	7700829764
Renault Laguna	IB56-	03/94-03/01	FLX38009R1028	7700842152
Renault Laguna	IB56-	03/94-03/01	FLX38009R1029	7700842153
Renault Laguna	IB56-	03/94-03/01	FLX38009R1030	7700846773
Renault Laguna	IB56-	03/94-03/01	FLX38009R1031	7700846772
Renault Laguna	IBreakK56-	03/94-03/01	FLX38009R1032	7700838006
Renault Laguna	IBreakK56-	03/94-04/98	FLX38009R1033	7700838005
Renault Laguna	IBreakK56-	04/98-03/01	FLX38009R1034	7700427547
Renault Laguna	IBreakK56-	05/94-04/98	FLX38009R1035	7700838005
Renault Laguna	IBreakK56-	03/94-04/98	FLX38009R1036	7700846538
Renault Laguna	IBB74	03/01-	FLX38009R1037	8200002902
Renault Laguna	IBB74	03/01-	FLX38009R1038	8200002020
Renault Laguna	IBreakK74	03/01-	FLX38009R1039	8200002896
Renault Laguna	IBreakK74	03/01-	FLX38009R1040	8200002896
Renault Laguna	IBreakK74	03/01-	FLX38009R1041	8200002903
Renault Laguna	IBreakK74	03/01-	FLX38009R1042	8200002317
Renault Megane	BAD	01/96-11/02	FLX38009R1043	7700828451
Renault Megane	BAD	01/96-11/02	FLX38009R1044	7700828451
Renault Megane	CabrioletEA0-	10/96-	FLX38009R1045	7700846404
Renault Megane	CabrioletEA0-	10/96-	FLX38009R1046	7700846464
Renault Megane	ClassicAD-	09/96-	FLX38009R1047	7700838612
Renault Megane	Coach/CoupeDAO-	03/96-01/01	FLX38009R1048	7700838487
Renault Megane	GrandtourKAD-	03/99-	FLX38009R1049	7700419411
Renault Megane	Saloon	03/99-	FLX38009R1049	7700421906
Renault Megane	Scenic95A-	01/97-08/99	FLX38009R1050	7700828454
Renault Megane	Scenic95A-	12/96-08/99	FLX38009R1051	7700828454
Renault Megane	Scenic99A	09/99-	FLX38009R1052	7700430022
Renault Megane	Scenic99A	09/99-	FLX38009R1053	7700828454
Renault Megane	Scenic99A	09/99-	FLX38009R1054	7700434465
Renault Megane	ScenicTT	01-	FLX38009R1055	7700430022
Renault Megane	ScenicTT	01-	FLX38009R1056	7700828454
Renault Megane	ScenicTT	01-	FLX38009R1057	7700434465



88 89 90 91 92 93
94 95 96 97 98 99
00 01 02 03 04 05
4 yıl / Year

Flexlift Ref. No.

OEM

Renault Megane	SportBAO-	03/99-11/02	FLX38009R1058	7700843698
Renault Megane	SportBAO-	03/99-11/02	FLX38009R1059	7700843698
Renault 11	B37 C37	09/84-11/86	FLX38009R1060	7701366529
Renault 11	B37 C37	09/84-11/86	FLX38009R1061	7702144784
Renault 11	B37 C37	12/86-90	FLX38009R1062	7702149568
Renault 19	B53 C53	11/88-04/92	FLX38009R1063	7700799026
Renault 19	B53 C53	11/88-12/95	FLX38009R1064	7700786248
Renault 19	B53 C53	11/88-12/95	FLX38009R1065	7700799027
Renault 19	B53 C53	04/92-12/95	FLX38009R1066	7700818237
Renault 19	ChamadE53	04/89-04/92	FLX38009R1067	7700811570
Renault 19	ChamadE53	04/92-12/95	FLX38009R1068	7700824817
Renault 21	B48	05/89-04/94	FLX38009R1069	7700795698
Renault 21	B48	05/89-04/94	FLX38009R1070	7700795731
Renault 21	K48Nevada	03/86-04/94	FLX38009R1071	7700785587
Renault 25	B29	09/86-02/93	FLX38009R1072	7701033344
Renault 25	B29	09/89-02/93	FLX38009R1073	7700760654
Renault 25	B29	09/89-02/93	FLX38009R1074	7700766584
Renault 25	B29	09/89-02/93	FLX38009R1075	7700766585
Renault 25	B29	09/89-02/93	FLX38009R1076	7701366154
Renault 25	B29	04/84-02/93	FLX38009R1077	7700753539
Renault 25	B29	04/84-02/93	FLX38009R1078	7700766586
Renault 25	B29	04/84-02/93	FLX38009R1079	7700766587
Renault 25	B29	04/84-02/93	FLX38009R1080	7701366153
Renault Safrane	IB54-	04/92-07/96	FLX38009R1081	7700812193
Renault Safrane	IB54-Baccara	04/92-07/96	FLX38009R1082	7700829825
Renault Safrane	IB54-Baccara	04/92-07/96	FLX38009R1083	7700825234
Renault Safrane	IB54-exc Baccara	04/92-07/96	FLX38009R1084	7700811019
Renault Safrane	IB54-exc Baccara	04/92-07/96	FLX38009R1085	7700819599
Renault Safrane	IB54-	08/96-12/00	FLX38009R1086	7700812193
Renault Safrane	IB54	08/96-12/00	FLX38009R1087	7700414002
Renault Safrane	IB54-	08/96-12/00	FLX38009R1088	7700413083
Renault Super	SB40 C40	01/85-06/91	FLX38009R1089	7702144629
Renault Super	SB40,C40Baccara	01/85-06/91	FLX38009R1090	7700787749
Renault Trafic	P	-03/80	FLX38009R1091	7700691359
Renault Trafic	P	-03/80	FLX38009R1092	7701349492
Renault Twingo	I&IC06	03/93-	FLX38009R1093	7700815135

ROVER

Rover 25	RF	1C/99-	FLX38009R2001	BHE45001
Rover 45	RT	02/00-	FLX38009R2002	BHE140020
Rover 75	RJ	02/99-	FLX38009R2003	BMH500010
Rover 200	RF	11/95-03/00	FLX38009R2004	BHE45001
Rover 200	RF	11/95-03/00	FLX38009R2005	GST 159
Rover 200	XH,XWGTI	03/85-10/95	FLX38009R2006	BHE38025
Rover 200	XH,XWGTI	03/85-10/95	FLX38009R2007	GST 120
Rover 200	XH,XWGTI	03/85-10/95	FLX38009R2008	BHE38017
Rover 200	XH,XWGTI	03/85-10/95	FLX38009R2009	GST122
Rover 400	RT	05/95-03/00	FLX38009R2010	BHE140010
Rover 400	RT	05/95-03/00	FLX38009R2011	BHE140020
Rover 800	xs	10/86-10/92	FLX38009R2012	BHM410040
Rover 800	xs	10/92-02/99	FLX38009R2013	BHE41003
Rover 800	xs	10/92-02/99	FLX38009R2014	BHE41004
Rover 800	xs	10/92-02/99	FLX38009R2015	BHE41003
Rover 800	xs	10/92-02/99	FLX38009R2016	BHE41004
Rover Metro	XF	84-89	FLX38009R2017	
Rover MiniMetro	XF	89-84	FLX38009R2018	BHE39005
Rover MiniMetro	Mini Metro	80-	FLX38009R2019	AFPI282
Range Rover	ChassisB	86-77/94	FLX38009R2020	392916
Range Rover	ChassisC	07/70-86	FLX38009R2021	MXC7833
Range Rover	Classic	07/70-86	FLX38009R2022	
Rover 8	Rover 8	03/85-10/95	FLX38009R2023	

SAAB

Saab 900	Y53D	10/93-03/98	FLX38009S1001	4326468
Saab 900	Y53D	10/93-03/98	FLX38009S1002	4324307
Saab 900	ICoupe	11/78-09/93	FLX38009S1003	9293580
Saab 9000		09/84-05/98	FLX38009S1004	9270240
Saab 9000	H1007932,H8000100	87-08/91	FLX38009S1005	6956288

SEAT

Seat Alhambra	7MS	09/95-07/00	FLX38009S2001	7M08275500
Seat Alhambra	7MS	09/95-07/00	FLX38009S2002	7M0827550F
Seat Alhambra	7MS	09/95-07/00	FLX38009S2003	7M0827550G
Seat Alhambra	7MS	06/00-	FLX38009S2004	7M3823359A
Seat Alhambra	7MS	06/00-	FLX38009S2005	7M0827550G
Seat Arosa	6H	01/97-	FLX38009S2006	6X0827550
Seat Arosa	6H	01/97-	FLX38009S2007	6X0827550A
Seat Arosa	6H	01/97-	FLX38009S2008	8L0823359
Seat Arosa	6H	01/97-	FLX38009S2009	6E0827550C
Seat Cordoba	948R976K2,6C2	02/93-06/99	FLX38009S2010	6K5827550



88 89 90 91 92 93
94 95 96 97 98 99
00 01 02 03 04 05
Çil / Year

Flexlift Ref. No.

OEM

Seat Cordoba	94& 97&K2,6C2	02/93-06/99	FLX38009052011	W06K527550
Seat Cordoba	94& 97/bkz,6kz	02/93-06/99	FLX38009052012	W06K527550
Seat Cordoba	94& 97&K2,6C2	02/93-06/99	FLX38009052013	W06K527550
Seat Cordoba	97VarioK5	09/96-06/99	FLX38009052014	6K0827550
Seat Cordoba	97VarioK5	09/96-06/99	FLX38009052015	6K0827550A
Seat Cordoba	99VarioK5	06/99-	FLX38009052016	6K0827550
Seat Cordoba	99VarioK5	06/99-	FLX38009052017	6K0827550A
Seat Ibiza	1021A	06/84-12/93	FLX38009052018	SE02156200A
Seat Ibiza	1021A	06/84-12/93	FLX38009052019	X039503120
Seat Ibiza	1021A	06/84-12/93	FLX38009052020	X039507910
Seat Ibiza	116K1	12/93-08/99	FLX38009052021	6K6827550
Seat Ibiza	116K1	12/93-08/99	FLX38009052022	W06K6827550
Seat Ibiza	116K1	12/93-08/99	FLX38009052023	6K6827550
Seat Ibiza	116K1	12/93-08/99	FLX38009052024	W06K6827550
Seat Leon	1M	11/99-	FLX38009052025	1M6827550A
Seat Leon	1M	11/99-	FLX38009052026	1M6827550A
Seat Malaga	023A	11/84-12/93	FLX38009052027	SE023529200A
Seat Malaga	023A	11/84-12/93	FLX38009052028	X03953290
Seat Marbella	Marbella 28	08/86-10/98	FLX38009052029	SE028526200
Seat Marbella	Marbella 28	08/86-10/98	FLX38009052030	X03961930
Seat Panda	Panda	80-87	FLX38009052031	SE14521200A
Seat Panda	Panda	80-87	FLX38009052032	X044836580
Seat Toledo	11L	01/91-03/99	FLX38009052033	110827550
Seat Toledo	11L	01/91-03/99	FLX38009052034	110827550A
Seat Toledo	11L	01/91-03/99	FLX38009052035	W0110827550
Seat Toledo	11L1M2	04/99-	FLX38009052036	1M58275508
SKODA				
Skoda Fabia	6Y2	11/99-	FLX38009053001	6Y0827550A
Skoda Fabia	KombiY5	11/00-	FLX38009053002	6Y0827550A
Skoda Octavia	KombiU	07/98-	FLX38009053003	1U9827550
Skoda Octavia	KombiU	07/98-	FLX38009053004	1U9827550A
Skoda Octavia	Sedan1U	09/96-09/00	FLX38009053005	1U6827550
Skoda Octavia	Sedan1U	09/96-09/00	FLX38009053006	1U6827550A
Skoda Octavia	Sedan1U	09/96-09/00	FLX38009053007	1U6827550B
Skoda Octavia	Sedan1U	09/96-09/00	FLX38009053008	1U6827550C
Skoda Octavia	Sedan1U	09/00-	FLX38009053009	1U6827550F
Skoda Octavia	Sedan1U	09/00-	FLX38009053010	1U6827550E
SUZUKI				
Suzuki Jimny	FJ	09/98-	FLX38009054001	8185181A02
Suzuki Vitara	ETJA	07/88-03/98	FLX38009054002	8185185C00
Suzuki Vitara	ETJA	07/88-03/98	FLX38009054003	9390085C00
TALBOT				
Talbot 150	150		FLX38009011001	17715500
TOYOTA				
CAMRY	SV20-SV21-CV20 RIGHT	10.86-03.92	FLX38009072001	68960-39077
CAMRY	SV20-SV21-CV20LEFT	10.86-03.92	FLX38009072002	68950-39207
CARINA	AT151-ST151	10.83-12.87	FLX38009072003	68950-20030
CARINA	AT171-ST171-CT170RIGHT	01.88-92	FLX38009072004	68950-29645
CARINA	AT171-ST171-CT170 LEFT	01.88-92	FLX38009072005	68960-29455
CARINA SW	AT171-ST171-CT170RIGHT	01.88-10.92	FLX38009072006	68950-29875
CARINA SW	AT171-ST171-CT170 LEFT	01.88-10.92	FLX38009072007	68960-29675
COROLLA SW	KE70-CE70	08.79-05.92	FLX38009072008	68950-19275ci
COROLLA	AE/EE/CE80/AE82	05.83-05.87	FLX38009072009	68950-19425
COROLLA	EE80	05.83-05.87	FLX38009072010	68950-19545
COROLLA	EE90-AE92 RIGHT	05.87-05.92	FLX38009072011	68950-19805
COROLLA	EE90-AE92 LEFT	05.87-05.92	FLX38009072012	68960-19495
COROLLA	EE90-CE90-AE92 RIGHT	05.87-05.92	FLX38009072013	68950-19586
COROLLA	EE90-CE90-AE92 LEFT	05.87-05.92	FLX38009072014	68960-19286
COROLLA SW	EE90-CE90-AE92 RIGHT	05.87-05.92	FLX38009072015	68950-13080
COROLLA SW	EE90-CE90-AE92 LEFT	05.87-05.92	FLX38009072016	68960-13080
STARLET	EP70-FP71 RIGHT	10.84-89	FLX38009072017	68950-19526
STARLET	EP70-FP71 LEFT	10.84-89	FLX38009072018	68960-19256
STARLET	EP80 RIGHT	89-	FLX38009072019	68950-19705
STARLET	EP80 LEFT	89-	FLX38009072020	68960-19395
Vauxhall				
Vauxhall Astra	MkIII	09/84-08/91	FLX380090V1001	90159607
Vauxhall Astra	MkIII	09/87-08/91	FLX380090V1002	132711
Vauxhall Astra	MkIII	09/87-08/91	FLX380090V1003	90241995
Vauxhall Astra	MkIII	09/87-08/91	FLX380090V1004	90241996
Vauxhall Astra	MkIII	09/84-08/87	FLX380090V1005	132706
Vauxhall Astra	MkIII	09/84-08/87	FLX380090V1006	90159629
Vauxhall Astra	MkIII	09/84-08/87	FLX380090V1007	132705
Vauxhall Astra	MkIII	09/84-08/87	FLX380090V1008	90190203
Vauxhall Astra	MkIIISRGTE	09/84-08/91	FLX380090V1009	132703
Vauxhall Astra	MkIIISRGTE	09/84-08/91	FLX380090V1010	90191627
Vauxhall Astra	MkIII	09/91-09/98	FLX380090V1011	132721



88 89 90 91 92 93
94 95 96 97 98 99
00 01 02 03 04 05
Çil / Year

Flexlift Ref. No.

OEM

Vauxhall Astra	MkIII	09/91-09/98	FLX380090V1012	90341282
Vauxhall Astra	MkIII	09/91-09/98	FLX380090V1013	1527119
Vauxhall Astra	MkIII	09/91-09/98	FLX380090V1014	90341378
Vauxhall Astra	MkIII	09/91-09/98	FLX380090V1015	132720
Vauxhall Carlton	MkIII	09/86-03/94	FLX380090V1016	90246621
Vauxhall Cavalier	MkIII	08/88-11/95	FLX380090V1017	132716
Vauxhall Cavalier	MkIII	08/88-11/95	FLX380090V1018	90227936
Vauxhall Cavalier	MkIII	08/88-11/95	FLX380090V1019	132715
Vauxhall Cavalier	MkIII	08/88-11/95	FLX380090V1020	90227934
Vauxhall Corsa		03/93-	FLX380090V1021	132725
Vauxhall Corsa		03/93-	FLX380090V1022	90388707
Vauxhall Nova		09/82-03/93	FLX380090V1023	90127137
Vauxhall Nova		09/82-03/93	FLX380090V1024	132712
Vauxhall Nova		09/82-03/93	FLX380090V1025	90127136
Vauxhall Omega		12/93-	FLX380090V1026	132675
Vauxhall Omega		12/93-	FLX380090V1027	90379081
VOLKSWAGEN				
VW Bora	U	1C/98-	FLX380090V2001	110823359
VW Bora	U	1C/98-	FLX380090V2002	810923359
VW Bora	U	1C/98-	FLX380090V2003	385827550A
VW Bora	U	1C/98-	FLX380090V2004	885827550C
VW Bora	U	1C/98-	FLX380090V2005	805827552C
VW Bora	U	1C/98-	FLX380090V2006	385827550A
VW Bora	VariantU	05/99-	FLX380090V2007	116827550
VW Caddy	114	01/82-95	FLX380090V2008	147827550
VW Corrado	531	08/88-12/95	FLX380090V2009	535827550A
VW Golf	ICabrioI55	01/79-08/93	FLX380090V2010	155827550A
VW Golf	ICabrioI55	01/79-08/93	FLX380090V2011	155827550B
VW Golf	H19Ech.19E78000	08/83-06/84	FLX380090V2012	191827550
VW Golf	H19Ech.19E780001	06/84-10/91	FLX380090V2013	116827550B
VW Golf	Mil HX	11/91-08/97	FLX380090V2014	116827550A
VW Golf	1111HX	11/91-08/97	FLX380090V2015	116827550A
VW Golf	IHCabrio 1 E7Ch. 1E1K010829	01/98-01/01	FLX380090V2016	810823359
VW Golf	IIICabrioI7	07/93-02/02	FLX380090V2017	116827550
VW Golf	IHCabrio 1E7	07/93-02/02	FLX380090V2018	116827550A
VW Golf	IIICabrioI7	07/93-02/02	FLX380090V2019	116827550B
VW Golf	IIIVariantHXO	07/93-04/99	FLX380090V2020	119827550A
VW Golf	IIIVariantH	07/93-97	FLX380090V2021	119827550A
VW Golf	IV1J	08/97-98	FLX380090V2022	110823359
VW Golf	IV1J	08/97-98	FLX380090V2023	110823359A
VW Golf	IV1J	08/97-98	FLX380090V2024	810823359
VW Golf	IV1J1	08/97-	FLX380090V2025	116827550
VW Golf	IV1J1	08/97-	FLX380090V2026	116827550C
VW Golf	IV1J1	08/97-	FLX380090V2027	119827550
VW Golf	IWariantU5	08/97-	FLX380090V2028	116827550
VW Golf	IWariantU5	08/97-	FLX380090V2029	116827550C
VW Golf	IWariantU5	08/97-	FLX380090V2030	119827550
VW Lupo	6X,6Exec.Git.Fsi,3LTDi	04/98-11/00	FLX380090V2031	6E0827550C
VW Lupo	Ch.6X1049577	04/98-11/00	FLX380090V2032	6X0823359A
VW Lupo	6X,6Efsi,3LTDiCh.6E1010000	04/98-04/01	FLX380090V2033	6E0827550C
VW NewBeetle	9C	01/98-	FLX380090V2034	116827550B
VW NewBeetle	9C	01/98-	FLX380090V2035	110827550C
VW Passat	IIVariant32B	08/80-03/88	FLX380090V2036	331827550B
VW Passat	IIVariant32B	08/80-03/88	FLX380090V2037	331827550C
VW Passat	IIIVariant5ci	02/88-05/97	FLX380090V2038	348827550
VW Passat	IIIVariant35I	02/88-05/97	FLX380090V2039	348827550
VW Passat	IV3B2	08/96-11/00	FLX380090V2040	380823359A
VW Passat	IV3B2	08/96-11/00	FLX380090V2041	380823359
VW Passat	IV3B2	08/96-11/00	FLX380090V2042	480823359B
VW Passat	IV3B2	08/96-11/00	FLX380090V2043	480823359C
VW Passat	IV3B2	08/96-11/00	FLX380090V2044	480823359C
VW Passat	IV3B2	08/96-11/00	FLX380090V2045	385827550A
VW Passat	IV3B2	08/96-11/00	FLX380090V2046	885827550C
VW Passat	IV3B2	08/96-11/00	FLX380090V2047	805827552C
VW Passat	IV3B2	08/96-11/00	FLX380090V2048	805827552F
VW Passat	IV3B2	08/96-11/00	FLX380090V2049	385827550
VW Passat	IWVariant385	05/97-11/00	FLX380090V2050	380823359A
VW Passat	IWVariant385	05/97-11/00	FLX380090V2051	380823359
VW Passat	IWVariant385	05/97-11/00	FLX380090V2052	380823359B
VW Passat	IWVariant385	05/97-11/00	FLX380090V2053	480823359B
VW Passat	IWVariant385	05/97-11/00	FLX380090V2054	480823359C
VW Passat	IWVariant385	05/97-11/00	FLX380090V2055	380827550
VW Passat	V3B3	05/00-	FLX380090V2056	380823359B
VW Passat	V3B3	05/00-	FLX380090V2057	385827550E
VW Passat	Variant386	05/00-	FLX380090V2058	380823359B
VW Passat	VVariant386	05/00-	FLX380090V2059	116827550
VW Passat	VVariant386	05/00-	FLX380090V2060	116827550C
VW Polo	6K2	07/97-07/99	FLX380090V2061	6K5827550A



88 89 90 91 92 93
94 95 96 97 98 99
00 01 02 03 04 05
Çift / Year

Flexlift Ref. No.



OEM

VW Polo	6KV2	07/97-07/99	FLX38009V2062	6K5827550A
VW Polo	6N1	10/94-10/99	FLX38009V2063	6N0027550A
VW Polo	6N1	10/94-10/99	FLX38009V2064	6N0827550A
VW Polo	6N2	10/99-09/01	FLX38009V2065	6N0827550A
VW Polo	6N2	10/99-09/01	FLX38009V2066	6N0827550A
VW Polo	86C	07/90-09/94	FLX38009V2067	867827550D
VW Polo	86CCh.86G170000	10/81-04/86	FLX38009V2068	867827550D
VW Polo	86CCh.86G170000	10/81-04/86	FLX38009V2069	867827550A
VW Polo	86CCh.86G170001	05/86-07/90	FLX38009V2070	867827550C
VW Polo	Coupe86C	10/81-07/90	FLX38009V2071	871827550A
VW Polo	Coupe86C	08/90-09/94	FLX38009V2072	871827550A
VW Polo	Coupe86C	08/90-09/94	FLX38009V2073	871827550A
VW Polo	Variant6KV5	04/97-09/01	FLX38009V2074	6K0827550D
VW Polo	Variant6KV5	04/97-09/01	FLX38009V2075	6K0827550A
VW Scirocco	II53B	08/80-87	FLX38009V2076	533827550D
VW Scirocco	II53B	87-07/92	FLX38009V2077	533827550A
VW Scirocco	II53B	87-07/92	FLX38009V2078	533827550A
VW Sharan	7M	09/95-07/00	FLX38009V2079	7M0827550D
VW Sharan	7M	09/95-07/00	FLX38009V2080	7M0827550F
VW Sharan	7M	09/95-07/00	FLX38009V2081	7M0827550G
VW Sharan	7M	08/00	FLX38009V2082	7M3827550A
VW Sharan	7M	08/00	FLX38009V2083	7M0827550G
VW Transporter/Bus	T2/T3	01/84-07/92	FLX38009V2084	251829311
VW Transporter/Bus	T2/T3	01/84-07/92	FLX38009V2085	251829311A
VW Transporter/Bus	T4 70XB,70XCCh.70-N-151781	01/90-07/92	FLX38009V2086	701829311F
VW Transporter/Bus	T4 70XB,70XCCh.70-N-151781	01/90-07/92	FLX38009V2087	701829311G
VW Transporter/Bus	T4 70XB,70XCCh.70-N-151781	01/90-07/92	FLX38009V2088	701829311H
VW Transporter/Bus	T470XB,70XCCh.70-N-151781Trim	01/90-07/92	FLX38009V2089	701829311J
VW Transporter/Bus	T470XB,70XCCh.70-N-151781	07/92	FLX38009V2090	701829311K
VW Transporter/Bus	T470XB,70XCCh.70-N-151781	07/92	FLX38009V2091	701829311R
VW Transporter/Bus	T470XB,70XCCh.70-N-151781	07/92	FLX38009V2092	701829311AB
VW Transporter/Bus	T470XB,70XCCh.70-N-151781HydroLift	07/92	FLX38009V2093	701829311T
VW Transporter/Bus	T470XB,70XCCh.70-N-151781Trim	07/92	FLX38009V2094	701829311S
VW Vento	1HX0	11/91-09/98	FLX38009V2095	1H5827550A
VW Vento	1HX0	11/91-09/98	FLX38009V2096	1H5827550B

VOLVO

Volvo 240	P242,P244	08/79-01/92	FLX38009V3001	1254057
Volvo 240	P245/Diesel	01/78-05/93	FLX38009V3002	1254916
Volvo 260	P262,P264	08/79-01/92	FLX38009V3003	1254057
Volvo 260	P265/Diesel	01/78-05/93	FLX38009V3004	1254916
Volvo 340		76-91	FLX38009V3005	3344245
Volvo 360		76-91	FLX38009V3006	3344245
Volvo 440		08/88-07/96	FLX38009V3007	3470348
Volvo 440		08/88-07/96	FLX38009V3008	3470350
Volvo 440		09/88-12/96	FLX38009V3009	3436644
Volvo 440		09/88-12/96	FLX38009V3010	3470350
Volvo 460		08/88-07/96	FLX38009V3011	3470348
Volvo 460		08/88-07/96	FLX38009V3012	3470350
Volvo 460		09/88-12/96	FLX38009V3013	3436644
Volvo 460		09/88-12/96	FLX38009V3014	3470350
Volvo 740	GLE	09/84-06/92	FLX38009V3015	1355363
Volvo 740	GLE	09/84-06/92	FLX38009V3016	6846014
Volvo 760	Kombi	09/84-06/92	FLX38009V3017	1355363
Volvo 760	Kombi	09/84-06/92	FLX38009V3018	6846014
Volvo 850	KombiLW	08/92-12/96	FLX38009V3019	3509482
Volvo 850	KombiLW	08/92-12/96	FLX38009V3020	9187115
Volvo 850	KombiLW	08/92-12/96	FLX38009V3021	9485548
Volvo 940		09/84-03/98	FLX38009V3022	1355263
Volvo 940		09/84-03/98	FLX38009V3023	6846014
Volvo 960	Kombi	09/84-03/98	FLX38009V3024	1355263
Volvo 960	Kombi	09/84-03/98	FLX38009V3025	6846014
Volvo 540	VS	07/95-	FLX38009V3026	852069
Volvo 540	VS	07/95-	FLX38009V3027	852060
Volvo 560		11/00-	FLX38009V3028	8600233
Volvo 560		11/00-	FLX38009V3029	8650233
Volvo 570		01/97-11/00	FLX38009V3030	9187795
Volvo 570		01/97-11/00	FLX38009V3031	9485546
Volvo 570		01/97-11/00	FLX38009V3032	9187796
Volvo 570		01/97-11/00	FLX38009V3033	9485547
Volvo 580		05/98-	FLX38009V3034	9483197
Volvo 580		05/98-	FLX38009V3035	9483199
Volvo V40	VW	07/95-	FLX38009V3036	803472
Volvo V70		01/97-03/00	FLX38009V3037	3509482
Volvo V70		01/97-03/00	FLX38009V3038	9187315
Volvo V70		01/97-03/00	FLX38009V3039	9485548
Volvo V70		03/00-	FLX38009V3040	8643086
Volvo V90		01/97-	FLX38009V3041	1355263
Volvo V90		01/97-	FLX38009V3042	6846014



Flexlift Ref. No.



OEM

AGCO (MASSEY FERGUSSON)			
CAB2 WINDOW	FLX380C90KA1001		3805354M1
CAB2 FRONT	FLX380C90KA1002		3806767M1
M F 135-152-158-230-240-250-265-290-298	FLX380C90KA1003		3806767M1
MF 675-690-689-689-T-699	FLX380C90KA1004		3303021M92
MF 2660-2625-2640-2645-2680-2685-2720-2725	FLX380C90KA1005		3303021M92
MF 3050-3060-3065-3070-3080-3090-3095-3115	FLX380C90KA1006		3303021M92
MF 3050-3060-3065-3070-3080-3090-3095-3115-3650-3655	FLX380C90KA1007		3389556M1
MF 3050-3060-3065-3070-3080-3090-3095-3115-3650-3655 DOOR	FLX380C90KA1008		3385316M91
MF 3650-3655	FLX380C90KA1009		3303021M92
TRACTOR	FLX380C90KA1010		3700493M1
AGRITAL			
ALL	FLX380C90KA2001		29.6190.1.90
ATLAS WEYHAUSEN			
1004-1104-1302-1304-1404-1602-1604-1704-1804	FLX380C90KA3001		1012244
1302-1304-1404	FLX380C90KA3002		3634535
1604-1704	FLX380C90KA3003		3634546
440	FLX380C90KA3004		2688195
604-804	FLX380C90KA3005		2688457
42E-52E	FLX380C90KA3006		1785248
BERTRAND FAURE			
BERTRAND FAURE	FLX380C90KB1001		3000620
BOSAL-SEKURA			
BOSAL-SEKURA VARIOUS CABIN	FLX380C90KB2001		963115
BREIDA			
BREIDA VARIOUS CABIN	FLX380C90KB3001		1AC1120
BREIDA VARIOUS CABIN	FLX380C90KB3002		1AC1118
BREIDA VARIOUS CABIN	FLX380C90KB3003		1AC1118
CASE			
MODEL 125	FLX380C90KC1001		C3036945
MX 30	FLX380C90KC1002		38944742
POCLAIN 1 NA	FLX380C90KC1003		P3836915K
STEYR TRACTOR M900-M9000	FLX380C90KC1004		1-99-976-015
STEYR TRACTOR 8060	FLX380C90KC1005		1-99-976-046
STEYR TRACTOR M900-M9000-M9100	FLX380C90KC1006		1-99-976-066
STEYR TRACTOR SERIE 80	FLX380C90KC1007		1-99-976-047
STEYR TRACTOR M9000-M9100	FLX380C90KC1008		1-99-976-065
PIOO(MAXUM)	FLX380C90KC1009		1531490C1
PIOO(MAXUM)	FLX380C90KC1010		1531489C1
PIOO(MAXUM)	FLX380C90KC1011		1971235C2
TRACTOR CABIN	FLX380C90KC1012		K303741
DAF-TRUCKS			
DAF 75 - DAF 85	FLX380C90KD1001		758296
DAF 2700	FLX380C90KD1002		98381
DEUTZ-FAHR			
DEUTZ-FAHR	FLX380C90KD2001		0443 3113
DEUTZ-FAHR	FLX380C90KD2002		0443 4780
DEUTZ-FAHR	FLX380C90KD2003		1604 4334
DEUTZ-FAHR	FLX380C90KD2004		1600 5716
DEUTZ-FAHR	FLX380C90KD2005		1601 4618
DEUTZ-FAHR	FLX380C90KD2006		0442 8681
DEUTZ-FAHR	FLX380C90KD2007		0441 6545
DEUTZ-FAHR	FLX380C90KD2008		0441 5239
DEUTZ-FAHR	FLX380C90KD2009		0440 2639
DEUTZ-FAHR	FLX380C90KD2010		0437 2748
DEUTZ-FAHR	FLX380C90KD2011		0439 9081
DEUTZ-FAHR	FLX380C90KD2012		0432 6223
DEUTZ-FAHR	FLX380C90KD2013		0650 3707
DEUTZ-FAHR	FLX380C90KD2014		0435 7779
DX3.105C-DX3.655C	FLX380C90KD2015		0437 3761
DX3.505C-DX3.705C-DX3.905C	FLX380C90KD2016		0435 7776
DX4.30-DX4.50-DX4.70-DX6.05-DX6.10-DX6.30-DX6.50-DX7.10	FLX380C90KD2017		0437 3763
EBRO			
Ebro Tractor	FLX380C90KE1001		3563371311
Ebro Tractor	FLX380C90KE1002		3E2227271
Ebro Tractor	FLX380C90KE1003		210102201
Ebro Tractor	FLX380C90KE1004		550102731
Ebro Tractor	FLX380C90KE1005		2117652
Ebro Tractor	FLX380C90KE1006		5565213
Ebro Tractor	FLX380C90KE1007		5542891
ERF TRUCKS			
SPS	FLX380C90KE2001		119256-0
FODEN TRUCKS			
TRUCK	FLX380C90KF1001		01-00331-100
TRUCK	FLX380C90KF1002		01-00331-000
HYMER			
CARAVAN BED	FLX380C90KH1001		352026



Flexlift Ref. No.



OEM

CARAVAN	FLX380090KH1002	352023
CARAVAN TUBE DOOR	FLX380090KH1003	352022
IVECO		
DOOR	FLX380090K11001	42332040
DOOR	FLX380090K11002	2583823
CANTIERISTICI DOOR	FLX380090K11003	42332040
315-470-570	FLX380090K11004	2583823
370	FLX380090K11005	4833074
370 LORRAINE	FLX380090K11006	61159076
370 LORRAINE	FLX380090K11007	61159078
370	FLX380090K11008	8461289
370 DOOR	FLX380090K11009	8458193
380 FRONT	FLX380090K11010	71101444
380 REAR	FLX380090K11011	4867858
380HD-380NL	FLX380090K11012	4867857
380 FRONT	FLX380090K11013	93196041
380 SIDE	FLX380090K11014	93171935
380 SIDE	FLX380090K11015	93171032
380 FRONT	FLX380090K11016	71101387
380 FRONT	FLX380090K11017	71101445
471	FLX380090K11018	4787130
471-571-671 DOOR	FLX380090K11019	4780118
480	FLX380090K11020	4825807
480 SIDE	FLX380090K11021	7978655
480 SIDE	FLX380090K11022	4826817
480-580-680	FLX380090K11023	4780119
490-380	FLX380090K11024	4853620
490	FLX380090K11025	98463694
491	FLX380090K11026	99480448
491 CITYBUS	FLX380090K11027	500314887
580-491	FLX380090K11028	7978657
591	FLX380090K11029	8179028
671	FLX380090K11030	4801038
671 J	FLX380090K11031	4791827
DAILY FURGONE GRANVOLUME REAR DOOR	FLX380090K11032	93930490
180 RADIATOR	FLX380090K11033	42332040
TRANSPORTER 40.10-40.8 (China)	FLX380090K11034	60141601
260 E30 EUROTECH SPR2	FLX380090K11035	98476371
75E14 60/1505SPR1	FLX380090K11036	98444262
190 E27 EUROTECH SPR2	FLX380090K11037	98476371
440 E34 EUROTECH SPR2	FLX380090K11038	98476371
107-190 RADIATOR	FLX380090K11039	8461289
256 M 19	FLX380090K11040	8461289
280 M 22	FLX380090K11041	8461289
320 M 19	FLX380090K11042	8461289
320 M 26	FLX380090K11043	8461289
PEGASO	FLX380090K11044	1008398
PEGASO	FLX380090K11045	1008397
PEGASO	FLX380090K11046	1008399
PEGASO	FLX380090K11047	1008234
PEGASO	FLX380090K11048	1008399
JOHN DEERE		
JOHN DEERE VARIOUS	FLX380090K11001	A2 44401
JOHN DEERE VARIOUS	FLX380090K11002	A2 46263
JOHN DEERE VARIOUS	FLX380090K11003	A2 47225
JOHN DEERE VARIOUS	FLX380090K11004	AL 58521
JOHN DEERE VARIOUS	FLX380090K11005	A2 45981
JOHN DEERE VARIOUS	FLX380090K11006	A2 43775
JOHN DEERE VARIOUS	FLX380090K11007	A2 81578
JOHN DEERE VARIOUS	FLX380090K11008	AL114803
JOHN DEERE VARIOUS	FLX380090K11009	AL110629
JOHN DEERE VARIOUS	FLX380090K11010	AL 78987
JOHN DEERE VARIOUS	FLX380090K11011	AL 82634
JOHN DEERE VARIOUS	FLX380090K11012	Z41385
JOHN DEERE VARIOUS	FLX380090K11013	AL 57949
LANDINI		
377-387-397	FLX380090K11001	3303021M92
SERIE 6550	FLX380090K11002	3303021M92
APPLICATION 265-275-290-550-560-575-590-595	FLX380090K11003	3384671
APPLICATION 3050-3060-3065-3070-3080-3090-2630-3650-3680	FLX380090K11004	3389556
APPLICATION 3050-3060-3065-3070-3080-3090-2630-3650-3680	FLX380090K11005	3303021
APPLICATION 3050-3060-3065-3070-3080-3090-2630-3650-3680	FLX380090K11006	3385316
MI	FLX380090K11007	3384671
MI	FLX380090K11008	3389556
M92	FLX380090K11009	3303021
M91	FLX380090K11010	3385316
MERCEDES		
403	FLX380090K11001	HXB 373 885 0035
303	FLX380090K11002	HXB 373 950 0078
403	FLX380090K11003	HXB 373 898 0145
303	FLX380090K11004	HXB 373 959 1085
403	FLX380090K11005	HXB 373 959 1185



Flexlift Ref. No.



OEM

303	FLX380090K11006	HXB 373 959 1285
303	FLX380090K11007	HXB 373 750 2980
403	FLX380090K11008	HXB 373 750 3080
403	FLX380090K11009	HXB 373 750 3180
403	FLX380090K11010	HXB 373 750 3280
303	FLX380090K11011	HXB 373 750 3480
403	FLX380090K11012	HXB 373 750 3680
3880	FLX380090K11013	HXB 373 750 3880
403	FLX380090K11014	HXB 373 750 4080 0402
304	FLX380090K11015	HXB 373 750 4180
403	FLX380090K11016	HXB 373 750 4580
304	FLX380090K11017	HXB 373 750 4680
403	FLX380090K11018	HXB 373 750 4780
403	FLX380090K11019	A 371 980 0064
403	FLX380090K11020	QB 26100 0001
403	FLX380090K11021	A 613 750 1356
403	FLX380090K11022	A 613 750 3056
403	FLX380090K11023	A 613 750 0180
403	FLX380090K11024	A 613 750 0280
403	FLX380090K11025	A 613 959 0385
403	FLX380090K11026	A 613 959 0185
403	FLX380090K11027	A 613 959 0285
403	FLX380090K11028	A 613 959 0385
403	FLX380090K11029	A 613 959 0485
403	FLX380090K11030	A 613 959 0585
403	FLX380090K11031	A 613 959 0785
403	FLX380090K11032	A 613 980 0064
403	FLX380090K11033	A 613 980 0164
403	FLX380090K11034	A 613 980 0464
403	FLX380090K11035	A 613 980 0564
403	FLX380090K11036	A 613 980 0664
403	FLX380090K11037	A 613 980 0764
403	FLX380090K11038	A 613 980 0864
403	FLX380090K11039	A 613 980 0964
403	FLX380090K11040	A 613 980 1064
403	FLX380090K11041	A 613 980 1164
403	FLX380090K11042	A 613 980 1264
403	FLX380090K11043	A 613 980 1364
403	FLX380090K11044	A 613 980 1564
403	FLX380090K11045	A 613 980 1764
403	FLX380090K11046	A 613 980 1864
403	FLX380090K11047	A 613 980 1964
403	FLX380090K11048	A 613 980 2064
403	FLX380090K11049	A 613 980 2164
403	FLX380090K11050	A 613 980 2264
403	FLX380090K11051	A 613 980 2864
403	FLX380090K11052	A 613 980 2964
403	FLX380090K11053	A 613 980 3064
403	FLX380090K11054	A 613 980 3164
403	FLX380090K11055	A 613 980 3364
403	FLX380090K11056	A 613 980 3564
403	FLX380090K11057	A 613 980 0164
403	FLX380090K11058	A 613 980 0264
403	FLX380090K11059	A 613 980 0464
403	FLX380090K11060	A 613 980 0564
403	FLX380090K11061	A 613 980 0664
403	FLX380090K11062	A 613 980 0764
403	FLX380090K11063	A 613 980 0864
403	FLX380090K11064	A 613 980 0964
403	FLX380090K11065	A 613 980 1064
403	FLX380090K11066	A 613 980 1164
403	FLX380090K11067	A 613 980 1264
404	FLX380090K11068	A 001 980 02 64
404	FLX380090K11069	A 001 980 03 64
404	FLX380090K11070	A 001 980 13 64
404	FLX380090K11071	A 001 980 16 64
404	FLX380090K11072	A 001 980 17 64
404	FLX380090K11073	A 001 980 18 64
404	FLX380090K11074	A 001 980 19 64
404	FLX380090K11075	A 001 980 20 64
404	FLX380090K11076	A 001 980 21 64
404	FLX380090K11077	A 001 980 04 64
404	FLX380090K11078	A 001 980 05 64
404	FLX380090K11079	A 001 980 06 64
404	FLX380090K11080	A 001 980 10 64
404	FLX380090K11081	A 001 980 11 64
404	FLX380090K11082	A 001 980 12 64
404	FLX380090K11083	A 001 980 22 64
404	FLX380090K11084	A 001 980 23 64
404	FLX380090K11085	A 001 980 24 64
404	FLX380090K11086	A 001 980 49 64
404	FLX380090K11087	A 001 980 26 64
404	FLX380090K11088	A 001 980 27 64
404	FLX380090K11089	A 001 980 28 64



Flexlift Ref. No.



OEM

404	FLX380090KM1090	A 001 980 51 64
404	FLX380090KM1091	A 001 980 52 04
953-1018/963m 0404	FLX380090KM1092	A 001 980 53 64
1092-1102 0404	FLX380090KM1093	A 001 980 54 64
1217-1271/1018m. 0404	FLX380090KM1094	A 001 980 55 64
1283-1365 1227 U. 1293m. 0404	FLX380090KM1095	A 001 980 56 64
1468-1490 1350m. 0404	FLX380090KM1096	A 001 980 57 64
1616/1478 U. 1500m. 1351m. 0404	FLX380090KM1097	A 001 980 58 64
1680-1690/1626m. 0404	FLX380090KM1098	A 001 980 59 64
1690m. 0404	FLX380090KM1099	A 001 980 60 64
070955 0405 0407	FLX380090KM1100	A 000 980 59 64
836532	FLX380090KM1101	A 000 980 92 64
0302/10R-11R-12R-13R	FLX380090KM1102	A 000 750 25 80
0302/10R-11R-12R-13R	FLX380090KM1103	A 000 750 23 80
0302/10R-11R-12R-13R	FLX380090KM1104	A 000 750 22 80
303	FLX380090KM1105	A 000 750 28 80
303	FLX380090KM1106	A 000 750 29 80
303	FLX380090KM1107	A 000 750 30 80
303	FLX380090KM1108	A 000 750 31 80
303	FLX380090KM1109	A 000 980 72 64
401	FLX380090KM1110	A 000 750 25 80
305	FLX380090KM1111	A 000 750 25 80
305	FLX380090KM1112	A 000 750 24 80
305	FLX380090KM1113	A 000 750 23 80
305	FLX380090KM1114	A 000 750 22 80
307	FLX380090KM1115	A 000 750 23 80
307	FLX380090KM1116	A 000 750 22 80
307	FLX380090KM1117	A 000 750 24 80
307	FLX380090KM1118	A 000 750 25 80
405	FLX380090KM1119	A 000 980 71 64
407	FLX380090KM1120	A 000 980 71 64
VITO 70	FLX380090KM1121	A 638 980 04 64
BRABUS	FLX380090KM1122	A 638 980 03 64
ML 320	FLX380090KM1123	A 163 740 00 45
NEW HOLLAND		
NEW HOLLAND VARIOUS	FLX380090KN1001	9832424
NEW HOLLAND VARIOUS	FLX380090KN1002	9594082
NEW HOLLAND VARIOUS	FLX380090KN1003	84024600
NEW HOLLAND VARIOUS	FLX380090KN1004	694130000
NEW HOLLAND VARIOUS	FLX380090KN1005	322325550
NEW HOLLAND VARIOUS	FLX380090KN1006	9509946
NEW HOLLAND VARIOUS	FLX380090KN1007	84015664
NEW HOLLAND VARIOUS	FLX380090KN1008	9814770
NEW HOLLAND VARIOUS	FLX380090KN1009	84024982
NEW HOLLAND VARIOUS	FLX380090KN1010	84018511
NEW HOLLAND VARIOUS	FLX380090KN1011	9837419
NEW HOLLAND VARIOUS	FLX380090KN1012	9837397
NEW HOLLAND BAGGER TERNA 06	FLX380090KN1013	858018270
NEW HOLLAND NH 75TLB-ALLIS FB95	FLX380090KN1014	858018270
NEW HOLLAND TRACTOR CABIN N.G.B CS32U-CS33	FLX380090KN1015	694130000
NEW HOLLAND TRACTOR CABIN N.G.B	FLX380090KN1016	44911645
NEW HOLLAND ALLIS FR9-FR7	FLX380090KN1017	79043799
NEW HOLLAND TRACTOR CABIN	FLX380090KN1018	5129427
NEW HOLLAND TRACTOR CABIN	FLX380090KN1019	5153193
NEW HOLLAND TRACTOR CABIN	FLX380090KN1020	5153206
NEW HOLLAND FIAT 1300 CABIN	FLX380090KN1021	9957682
SAME DEUTZ-FAHR GROUP		
SAME DEUTZ-FAHR GROUP CABIN	FLX380090KS1001	0009.8623.2
SAME DEUTZ-FAHR GROUP CABIN	FLX380090KS1002	0007.2751.0
SAME DEUTZ-FAHR GROUP CABIN	FLX380090KS1003	0008.2089.4/30/20
SAME DEUTZ-FAHR GROUP CABIN	FLX380090KS1004	0009.7738.4/70
SAME DEUTZ-FAHR GROUP CABIN	FLX380090KS1005	0009.8629.2
SAME DEUTZ-FAHR GROUP CABIN	FLX380090KS1006	0.9234.373.4
SAME DEUTZ-FAHR GROUP CABIN	FLX380090KS1007	0.8206.198.4/10
SAME DEUTZ-FAHR GROUP CABIN	FLX380090KS1008	0010.1579.0
SAME DEUTZ-FAHR GROUP TUR LASER 90-100-110-130-150 GALAXY 170	FLX380090KS1009	9233.167.4
SAME DEUTZ-FAHR GROUP TUR LASER 90-100-110-130-150 GALAXY 170	FLX380090KS1010	9233.167.4
SAME DEUTZ-FAHR GROUP ANTARES 100	FLX380090KS1011	9233.167.4
SAME DEUTZ-FAHR GROUP ANTARES 100	FLX380090KS1012	9241.140.4
SAME DEUTZ-FAHR GROUP CENTAURIAN 75	FLX380090KS1013	9233.167.4
SAME DEUTZ-FAHR GROUP CENTAURIAN 75	FLX380090KS1014	9241.140.4
SAME DEUTZ-FAHR GROUP EXPLORER 65-70-75-80 ANTARES	FLX380090KS1015	9233.167.4
SAME DEUTZ-FAHR GROUP EXPLORER 65-70-75-80 ANTARES	FLX380090KS1016	9241.140.4
SAME DEUTZ-FAHR GROUP HERCULES 160	FLX380090KS1017	9233.167.4
SAME DEUTZ-FAHR GROUP HERCULES 160	FLX380090KS1018	9241.140.4
SAME DEUTZ-FAHR GROUP TIGER SIX 105	FLX380090KS1019	9241.140.4
SAME DEUTZ-FAHR GROUP TIGER SIX 105	FLX380090KS1020	9233.167.4
SAME DEUTZ-FAHR GROUP TRIDENT 130	FLX380090KS1021	9233.167.4
SAME DEUTZ-FAHR GROUP TRIDENT 130	FLX380090KS1022	9241.140.4
SAME DEUTZ-FAHR GROUP CENTAURIO 70	FLX380090KS1023	9233.167.4
SAME DEUTZ-FAHR GROUP CENTAURIO 70	FLX380090KS1024	9241.140.4
SAME DEUTZ-FAHR GROUP LEOPARD 85-LEOPARD 90 TURBO	FLX380090KS1025	9233.167.4



Flexlift Ref. No.



OEM

SAME DEUTZ-FAHR GROUP LEOPARD 85-LEOPARD 90 TURBO	FLX380090KS1026	9241.140.4
SAME DEUTZ-FAHR GROUP JAGUAR 95	FLX380090KS1027	9233.167.4
SAME DEUTZ-FAHR GROUP JAGUAR 95	FLX380090KS1028	9241.140.4
SAME DEUTZ-FAHR GROUP TAURAS 60	FLX380090KS1029	9233.167.4
SAME DEUTZ-FAHR GROUP TAURAS 60	FLX380090KS1030	9241.140.4
SAME DEUTZ-FAHR GROUP EXPLORER 70H-80H-90T-90TH	FLX380090KS1031	9241.140.4
SAME DEUTZ-FAHR GROUP EXPLORER 70H-80H-90T-90TH	FLX380090KS1032	9233.167.4
SCANIA		
SCANIA VARIOUS	FLX380090KS2001	1369553
SCANIA VARIOUS	FLX380090KS2002	387729
SCANIA VARIOUS	FLX380090KS2003	438622
SCANIA VARIOUS	FLX380090KS2004	355309
SCANIA VARIOUS	FLX380090KS2005	440540
SCANIA VARIOUS	FLX380090KS2006	440539
SCANIA VARIOUS	FLX380090KS2007	353592
SCANIA VARIOUS	FLX380090KS2008	322929
SCANIA 113H VARIOUS	FLX380090KS2009	341299
SCANIA 113M VARIOUS	FLX380090KS2010	1123692
SCANIA 113M VARIOUS	FLX380090KS2011	341299
SCANIA 113M VARIOUS	FLX380090KS2012	1331164
SCANIA 124 VARIOUS	FLX380090KS2013	130692
SCANIA 124 VARIOUS	FLX380090KS2014	1306492
SIAC		
SIAC CABIN	FLX380090KS3001	200862AA
SIAC FIAT SERIE 66	FLX380090KS3002	400772AA
SIAC LANDINI TL 11	FLX380090KS3003	400799AA
SIAC RANGE 3/4 DOOR	FLX380090KS3004	402111AA
SIAC RANGE 3/4 SIDE	FLX380090KS3005	125405224
SIAC SAME GA	FLX380090KS3006	400772AA
SIAC SAME GA TOP	FLX380090KS3007	0.9234.373.4
SIAC SAME GA DOOR	FLX380090KS3008	400698AB
SIAC SAME GA MON. DOOR	FLX380090KS3009	200452AB
SIAC SAME GA MON. TOP	FLX380090KS3010	0.9234.373.4
SIAC SAME GM TOP	FLX380090KS3011	0.9234.373.4
SIAC SAME GM	FLX380090KS3012	0.8206.198.4/10
SIAC SAME GM DOOR	FLX380090KS3013	400698AB
SIAC SAME GMA	FLX380090KS3014	400772AA
SIAC SAME GMA TOP	FLX380090KS3015	0.9234.373.4
SIAC SAME GM DOOR	FLX380090KS3016	400698AB
SIAC LANDINI TL25/29	FLX380090KS3017	401219AA
SIAC RANGE	FLX380090KS3018	401219AA
SIAC FIAT 1300 DOOR	FLX380090KS3019	400698AB
SICURCAB		
SICURCAB VARIOUS CABIN	FLX380090KS4001	F9960892
STEYR		
TRACTOR 80 CABIN SK2	FLX380090KS5001	99-976-047
TRACTOR 80	FLX380090KS5002	99-976-036
TIM		
TIM CABIN	FLX380090KT1001	106471
TIM CABIN	FLX380090KT1002	106109
TIM CABIN	FLX380090KT1003	106281
VANGUARD		
VANGUARD 925-3600 KG	FLX380090KV1001	84875
VOLVO		
VOLVO WHELL LOADERS VARIOUS	FLX380090KV2001	11019023
VOLVO WHELL LOADERS VARIOUS	FLX380090KV2002	4881757
VOLVO WHELL LOADERS VARIOUS	FLX380090KV2003	11003943
VOLVO WHELL LOADERS VARIOUS	FLX380090KV2004	4881756
VOLVO WHELL LOADERS VARIOUS	FLX380090KV2005	11007080
VOLVO WHELL LOADERS VARIOUS	FLX380090KV2006	11025375
VOLVO WHELL LOADERS VARIOUS	FLX380090KV2007	11073553
VOLVO WHELL LOADERS VARIOUS	FLX380090KV2008	11026618
VOLVO WHELL LOADERS VARIOUS	FLX380090KV2009	11026285
VOLVO WHELL LOADERS VARIOUS	FLX380090KV2010	4881076
VOLVO WHELL LOADERS VARIOUS	FLX380090KV2011	4951642
VOLVO WHELL LOADERS VARIOUS	FLX380090KV2012	4939069
VOLVO WHELL LOADERS VARIOUS	FLX380090KV2013	782481
VOLVO WHELL LOADERS VARIOUS	FLX380090KV2014	11005803
VOLVO WHELL LOADERS VARIOUS	FLX380090KV2015	11005699
VOLVO BUS 12-600	FLX380090KV2016	7501271900007-00
VOLVO BUS 12-600	FLX380090KV2017	7501271900008-00
VOLVO BUS 12-600	FLX380090KV2018	7501271900005-00
VOLVO BUS 12-600	FLX380090KV2019	7501271900003-00
VOLVO BUS (STEYR-BUS) VARIOUS	FLX380090KV2020	5.8999E+11
VOLVO BUS (STEYR-BUS) VARIOUS	FLX380090KV2021	5.8999E+11
VOLVO BUS (STEYR-BUS) VARIOUS	FLX380090KV2022	5.8999E+11
VOLVO FL110 TRUCK VARIOUS	FLX380090KV2023	1611159
VOLVO FH12 VARIOUS	FLX380090KV2024	1619106
VOLVO COMPACT ZL 1002	FLX380090KV2025	28029135
VOLVO COMPACT ZL 402	FLX380090KV2026	43857191
BUS E325/E330H B12-500/600	FLX380090KV2027	750111000

Amortisör Sipariş Faks Formu / Gas Spring Ordering Fax Form

Lift

Türü Type	Standart Lift Standard Lift <input type="checkbox"/>	Paslanmaz Lift Stainless Lift <input type="checkbox"/>	Valfli Lift With Valve Lift <input type="checkbox"/>	Damper Damper <input type="checkbox"/>
--------------	---	---	---	---

Basma Kuvveti / Extension Force
N

Mil Kaplaması / Rod Plating
 Siyah / Black Krom / Chrome

Boru Rengi / Tube Color
 Siyah / Black Beyaz / White

Diğer / Other

Miktar / Quantity

Teslim Tarihi / Delivery Date

Boru Başlığı Kodu
Tube Connection Code

Mil Başlığı Kodu
Rod Connection Code

LE: Açık Boy / Extended Length
Ls: Strok / Stroke

DR: Mil Çapı / Rod Diameter
Dt: Boru Çapı / Tube Diameter

Isim / Soyisim
Name / Surname

Kargo Adresi
Cargo Address

Şirket
Company

Telefon
Telephone

E-Posta
E-mail

Diğer Teknik Detaylar
Other Technical Details

Amortisör Sipariş Faks Formu / Gas Spring Ordering Fax Form

Kilitli / Lockable

Türü Type	Esnek Flexible <input type="checkbox"/>	Rijit Rigid <input type="checkbox"/>
--------------	--	---

Basma Kuvveti / Extension Force
N

Mil Kaplaması / Rod Plating
 Siyah / Black Krom / Chrome

Boru Rengi / Tube Color
 Siyah / Black Beyaz / White

Diğer / Other

Miktar / Quantity

Teslim Tarihi / Delivery Date

Boru Başlığı Kodu
Tube Connection Code

Mil Başlığı Kodu
Rod Connection Code

LE: Açık Boy / Extended Length
Ls: Strok / Stroke

DR: Mil Çapı / Rod Diameter
Dt: Boru Çapı / Tube Diameter

Isim / Soyisim
Name / Surname

Kargo Adresi
Cargo Address

Şirket
Company

Telefon
Telephone

E-Posta
E-mail

Diğer Teknik Detaylar
Other Technical Details

Faks / Fax +90 352 321 31 62 +90 352 321 31 63



Çözüm ortağınız
Your solutions partner

ÖZDEMİR
MAL ZEMECİLİK

flexlift
GAZLİ AMORTİSÖR / GAS SPRINGS

ÖZDE
ELASTİK WİEBİNG & FITİL
ELASTIC WEBBING & MATTRESS EDGE TAPE

ÖZKA
SİRALI, BORULU, KARTON & GRÜMÜKAPLIYA
SPIRAL, CARDBOARDS & LAMINATION GREY CARDBOARD

ÖZYAY
BONELER, YAY & ÇEKİLME TELİ
BONNEL, SPRINGS & SPRINGS STEEL WIRE

SİMEKS
YAPıştırıcı / ADHESIVE

FLEXLINE
ZİMBAR TELİ / STAPLES



+ **projelendirme ve uygulama**
projecting and implementation

+ **hızlı servis**
fast service

+ **çözüm ortağınız**
your solutions partner



+ **sınırsız iletişim desteği**
unlimited communication support

+ **yüksek teknoloji**
high technology

+ **mühendislik hizmetleri**
engineering services

1000 adet
2018/2019
Cemalim Dinet
www.kosgeb.gov.tr
0332 221 69 71-82
T.C. SANAYİ VE TİCARET BAKANLIĞI
KOSGEB
www.kosgeb.gov.tr
TSEK
TUV
TIC



Özdemir Amortisör Sanayi ve Tic. Ltd. Şti.
1. O.S.B 18. Cad. No: 11/B Pk. 38070 KAYSERİ
Tel: +90 352 321 43 53 (pbx) Fax: +90 352 321 43 54
www.flexlift.com.tr